

Coaxial Technology

Distribution equipment, wall outlets and cables

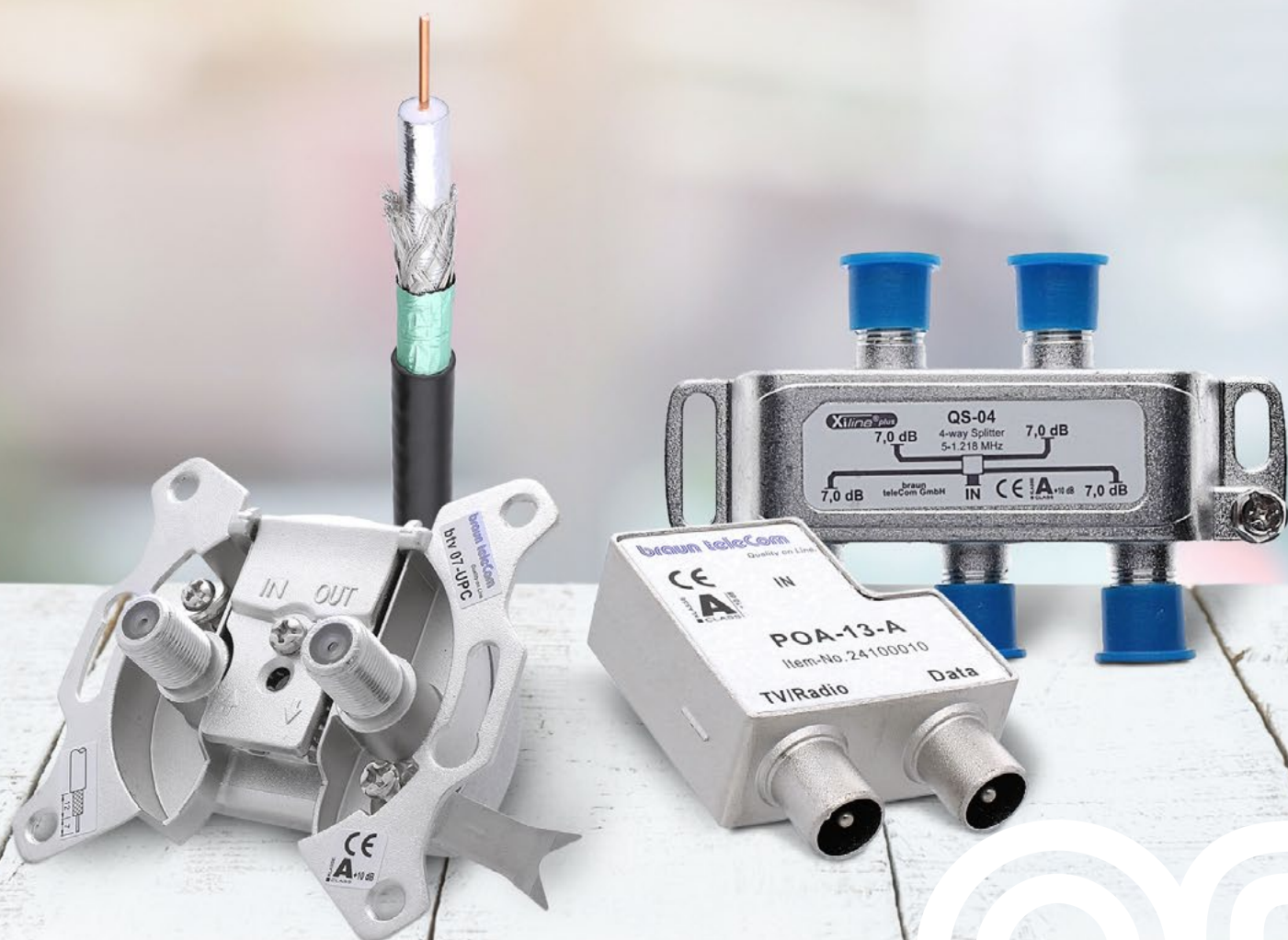

braun teleCom products have stood for competence and continuity for more than 35 years. Extensive experience and constantly growing know-how make the components and systems an integral part of many FTTH and HFC broadband networks.

While, in many areas, our activities focus on the development and production of our own products, we also serve as distributor for selected high-performance partners to achieve best possible customer satisfaction.

braun teleCom is a product brand of Netceed. We are a global leader in distribution, logistics, technical engineering, and product design with over 30 years of expertise and performance supporting the telecommunications and broadband industry.

Founded in 1993 by Cédric Varasteh, Netceed supplies and distributes a comprehensive range of passive and active equipment and tooling for network deployment, upgrades, and maintenance, supporting all technologies including FTTH, FTTX, HFC, Wi-Fi, 5G/Mobile, and Data Center.

Netceed employs over 2.000 people across 19 countries and counting, and its experienced team works hard every day shaping the future of communication networks across the globe.



CONTENT

1. COAXIAL TECHNOLOGY

Passive distribution equipment	3
<i>"XiLine plus" taps and splitters</i>	<i>4</i>
<i>"Signia" taps and splitters</i>	<i>7</i>
<i>Outdoor splitters and taps</i>	<i>9</i>
<i>Remote power filters and equalizers</i>	<i>13</i>
<i>Shrink sleeves</i>	<i>15</i>
<i>Snap-On wire markers</i>	<i>16</i>
<i>Connectors</i>	<i>17</i>
<i>Cable fittings</i>	<i>26</i>
<i>Jumper cables</i>	<i>29</i>
<i>Adapters and terminators</i>	<i>30</i>
<i>CATV accessories</i>	<i>32</i>
<i>Galvanic isolators</i>	<i>39</i>
<i>Block filters</i>	<i>41</i>
Antenna wall outlets	45
<i>Broadband antenna outlets up to 2 GHz</i>	<i>46</i>
<i>2-port multimedia broadband antenna outlets</i>	<i>48</i>
<i>Broadband push on adapters</i>	<i>49</i>
<i>3-port SAT antenna outlet</i>	<i>52</i>
<i>3-port multimedia antenna outlets</i>	<i>53</i>
<i>4-port multimedia/SAT antenna outlets</i>	<i>55</i>
<i>4-port multimedia antenna outlets</i>	<i>56</i>
<i>Accessories</i>	<i>57</i>
<i>Subscriber connection cables</i>	<i>58</i>
Coaxial cables	61
<i>Ören Kablo</i>	<i>62</i>
<i>Belden</i>	<i>63</i>
<i>Trunk cables</i>	<i>64</i>
<i>Fireproof cables</i>	<i>65</i>
CATV amplifiers	67
<i>Astro and Axing</i>	<i>68</i>
<i>Delta Electronics, Kathrein and Teleste</i>	<i>69</i>
<i>Triax and fixed-value attenuator pads</i>	<i>70</i>

2. CABINETS AND ACCESSORIES FOR POWER SUPPLY

3. OPTICAL SYSTEMS

4. TOOLS

5. CLICK & GO

6. AUTHORIZED DISTRIBUTION

PASSIVE DISTRIBUTION EQUIPMENT

Do you have questions concerning our products or want to place an order?

We look forward to your call!
+49 511 757086

Do you already know, which products you need?
shop.brauntelecom.com

"XiLine plus" taps and splitters

2-way, 3-way, 4-way, 6-way and 8-way splitters

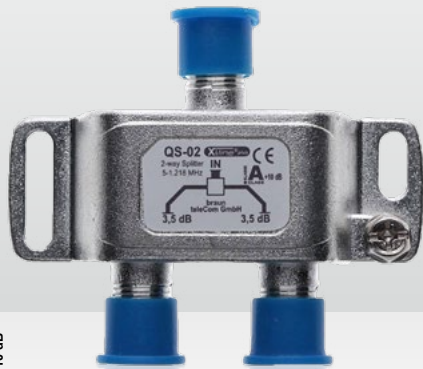

50002001
QS-02

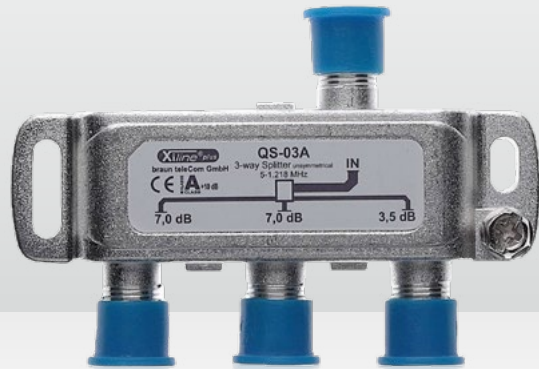

50003501
QS-03A

■ KLASSE
A
CLASS I
+10 dB

XiLine[®] plus

- Frequency range 5 – 1.218 MHz
- High-grade ferrit technology with excellent intermodulation resistance
- 360° gold plated inner conductors, high-grade dielectric inserts for excellent linearity and adaptation
- Housing plated with CuSn white bronze
- Block capacitors at each in- and output port against DC hum modulation
- Compact die-cast housing with grounding connections
- 6-way and 8-way splitters as well as 4-way, 6-way and 8-way taps are mountable in horizontal and vertical positions
- High screening factor (≥ 110 dB) exceeding EN 50083-2 Class A +10 dB
- Return loss > 22 dB at 47 MHz -1,5 dB/Oct. according EN 60728-4 Grade 1

Parameter	Frequency [MHz]	2-way splitter QS-02	3-way splitter QS-03	3-way splitter unbalanced QS-03A	4-way splitter QS-04
Through loss [dB]	5 – 10	3,5 ± 0,3	5,5 ± 0,3	3,5/2 × 7,0 ± 0,3	7,0 ± 0,3
	10 – 65	3,5 ± 0,3	5,5 ± 0,3	3,5/2 × 7,0 ± 0,3	7,0 ± 0,3
	65 – 470	3,5 ± 0,3	5,5 ± 0,5	3,5/2 × 7,0 ± 0,5	7,0 ± 0,5
	470 – 862	3,5 ± 0,5	5,5 ± 0,8	3,5/2 × 7,0 ± 0,8	7,0 ± 0,8
	862 – 1.006	3,5 ± 0,8	5,5 ± 1,0	3,5/2 × 7,0 ± 1,0	7,0 ± 1,0
Isolation [dB typ.]	1.006 – 1.218	3,5 ± 1,2	5,5 ± 1,2	3,5/2 × 7,0 ± 1,2	7,0 ± 1,2
	5 – 10	> 25	> 22	> 23	> 28
	10 – 65	> 30	> 30	> 30	> 33
	65 – 470	> 28	> 28	> 28	> 28
	470 – 862	> 26	> 26	> 25	> 26
Dimensions (W x H x D) [mm]	862 – 1.006	> 24	> 24	> 24	> 24
	1.006 – 1.218	> 20	> 22	> 22	> 22
	Order No.	58 x 53 x 18	80 x 53 x 18	80 x 53 x 18	80 x 53 x 18
Order No.		50002001	50003001	50003501	50004001

Parameter	Frequency [MHz]	6-way splitter QS-06	8-way splitter QS-08
Through loss [dB]	5 – 10	9,5 ± 0,3	11,0 ± 0,3
	10 – 65	9,5 ± 0,3	11,0 ± 0,3
	65 – 470	9,5 ± 0,5	11,0 ± 0,5
	470 – 862	9,5 ± 0,8	11,0 ± 0,8
	862 – 1.006	9,5 ± 1,0	11,0 ± 1,0
Isolation [dB typ.]	1.006 – 1.218	9,5 ± 1,3	11,0 ± 1,5
	5 – 10	> 28	> 26
	10 – 65	> 33	> 30
	65 – 470	> 28	> 26
	470 – 862	> 26	> 24
Dimensions (W x H x D) [mm]	862 – 1.006	> 24	> 22
	1.006 – 1.218	> 22	> 20
	Order No.	133 x 46,5 x 38	155 x 46,5 x 38
Order No.	50006001	50008001	



50003501
QS-03A



50004001
QS-04



50006001
QS-06



50008001
QS-08

Subject to technical changes!

1-way, 2-way and 3-way taps

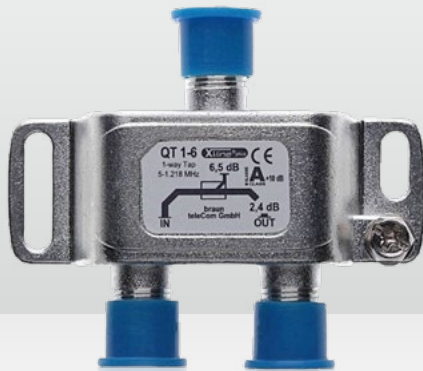

50106001
QT-1-6



50312001
QT-3-12

Parameter	Frequency [MHz]	1-way taps					
		QT-1-6	QT-1-8	QT-1-10	QT-1-12	QT-1-16	QT-1-20
Through loss [dB]	5 – 10	2,4 ± 0,3	1,8 ± 0,3	1,2 ± 0,3	0,8 ± 0,3	0,7 ± 0,3	0,5 ± 0,3
	10 – 65	2,4 ± 0,3	1,8 ± 0,3	1,2 ± 0,3	0,8 ± 0,3	0,7 ± 0,3	0,5 ± 0,3
	65 – 470	2,4 ± 0,5	1,8 ± 0,5	1,2 ± 0,5	0,8 ± 0,5	0,7 ± 0,3	0,5 ± 0,3
	470 – 862	2,4 ± 0,6	1,8 ± 0,6	1,2 ± 0,6	0,8 ± 0,6	0,7 ± 0,5	0,5 ± 0,5
	862 – 1.006	2,4 ± 0,8	1,8 ± 0,8	1,2 ± 0,8	0,8 ± 0,8	0,7 ± 0,5	0,5 ± 0,5
	1.006 – 1.218	2,4 ± 1,0	1,8 ± 1,0	1,2 ± 1,0	0,8 ± 1,0	0,7 ± 0,8	0,5 ± 0,8
Tap loss [dB]	5 – 10	6,5 ± 0,8	8,5 ± 0,5	10,5 ± 0,5	12,5 ± 0,5	16,0 ± 0,5	20,0 ± 0,5
	10 – 65	6,5 ± 0,5	8,5 ± 0,5	10,5 ± 0,5	12,5 ± 0,5	16,0 ± 0,5	20,0 ± 0,5
	65 – 470	6,5 ± 0,5	8,5 ± 0,5	10,5 ± 0,5	12,5 ± 0,5	16,0 ± 0,5	20,0 ± 0,5
	470 – 862	6,5 ± 0,8	8,5 ± 0,8	10,5 ± 0,8	12,5 ± 0,8	16,0 ± 0,8	20,0 ± 0,8
	862 – 1.006	6,5 ± 1,0	8,5 ± 1,0	10,5 ± 1,0	12,5 ± 1,0	16,0 ± 1,0	20,0 ± 1,0
	1.006 – 1.218	6,5 ± 1,2	8,5 ± 1,2	10,5 ± 1,2	12,5 ± 1,2	16,0 ± 1,2	20,0 ± 1,2
Directivity [dB typ.]	5 – 10	> 40	> 35	> 40	> 45	> 45	> 45
	10 – 65	> 40	> 35	> 40	> 45	> 45	> 45
	65 – 470	> 30	> 30	> 30	> 35	> 35	> 38
	470 – 862	> 26	> 25	> 25	> 30	> 30	> 32
	862 – 1.006	> 26	> 23	> 23	> 30	> 28	> 30
	1.006 – 1.218	> 22	> 22	> 20	> 26	> 26	> 28
Dimensions (W x H x D) [mm]	58 x 53 x 18						
Order No.		50106001	50108001	50110001	50112001	50116001	50120001

Parameter	Frequency [MHz]	2-way taps					3-way taps		
		QT-2-8	QT-2-10	QT-2-12	QT-2-16	QT-2-20	QT-3-12	QT-3-16	QT-3-20
Through loss [dB]	5 – 10	3,9 ± 0,5	2,2 ± 0,5	1,3 ± 0,5	1,2 ± 0,3	0,9 ± 0,3	2,8 ± 0,5	2,2 ± 0,5	1,8 ± 0,5
	10 – 65	3,9 ± 0,5	2,2 ± 0,5	1,3 ± 0,5	1,2 ± 0,3	0,9 ± 0,3	2,8 ± 0,5	2,2 ± 0,5	1,8 ± 0,5
	65 – 470	3,9 ± 0,5	2,2 ± 0,5	1,3 ± 0,5	1,2 ± 0,5	0,9 ± 0,3	2,8 ± 0,5	2,2 ± 0,5	1,8 ± 0,5
	470 – 862	3,9 ± 0,6	2,2 ± 0,6	1,3 ± 0,6	1,2 ± 0,6	0,9 ± 0,5	2,8 ± 0,8	2,2 ± 0,8	1,8 ± 0,8
	862 – 1.006	3,9 ± 1,0	2,2 ± 1,0	1,3 ± 1,0	1,2 ± 1,0	0,9 ± 0,8	2,8 ± 1,0	2,2 ± 1,0	1,8 ± 1,0
	1.006 – 1.218	3,9 ± 1,2	2,2 ± 1,5	1,3 ± 1,2	1,2 ± 1,2	0,9 ± 1,2	2,8 ± 1,5	2,2 ± 1,5	1,8 ± 1,5
Tap loss [dB]	5 – 10	8,5 ± 0,5	10,5 ± 0,5	12,5 ± 0,5	16,0 ± 0,5	20,0 ± 0,5	12,5 ± 0,5	16,0 ± 0,5	20,0 ± 0,5
	10 – 65	8,5 ± 0,5	10,5 ± 0,5	12,5 ± 0,5	16,0 ± 0,5	20,0 ± 0,5	12,5 ± 0,5	16,0 ± 0,5	20,0 ± 0,5
	65 – 470	8,5 ± 0,5	10,5 ± 0,5	12,5 ± 0,5	16,0 ± 0,5	20,0 ± 0,5	12,5 ± 0,5	16,0 ± 0,5	20,0 ± 0,5
	470 – 862	8,5 ± 0,8	10,5 ± 0,8	12,5 ± 0,8	16,0 ± 0,8	20,0 ± 0,8	12,5 ± 0,8	16,0 ± 0,8	20,0 ± 0,8
	862 – 1.006	8,5 ± 1,0	10,5 ± 1,0	12,5 ± 1,0	16,0 ± 1,0	20,0 ± 1,0	12,5 ± 1,0	16,0 ± 1,0	20,0 ± 1,0
	1.006 – 1.218	8,5 ± 1,2	10,5 ± 1,2	12,5 ± 1,2	16,0 ± 1,2	20,0 ± 1,2	12,5 ± 1,2	16,0 ± 1,2	20,0 ± 1,2
Isolation [dB typ.]	5 – 10	> 32	> 40	> 45	> 50	> 50	> 36	> 40	> 45
	10 – 65	> 32	> 40	> 45	> 50	> 50	> 40	> 40	> 45
	65 – 470	> 28	> 38	> 40	> 42	> 42	> 36	> 40	> 42
	470 – 862	> 28	> 34	> 34	> 35	> 35	> 34	> 36	> 36
	862 – 1.006	> 28	> 32	> 30	> 33	> 33	> 32	> 32	> 34
	1.006 – 1.218	> 28	> 28	> 30	> 32	> 32	> 30	> 32	> 32
Directivity [dB typ.]	5 – 10	> 26	> 30	> 32	> 35	> 40	> 26	> 35	> 35
	10 – 65	> 26	> 30	> 34	> 35	> 40	> 26	> 35	> 35
	65 – 470	> 23	> 28	> 32	> 32	> 32	> 26	> 30	> 32
	470 – 862	> 22	> 26	> 25	> 27	> 27	> 22	> 26	> 28
	862 – 1.006	> 22	> 26	> 25	> 25	> 25	> 20	> 26	> 26
	1.006 – 1.218	> 22	> 24	> 22	> 23	> 23	> 20	> 22	> 24
Dimensions [mm]	80 x 53 x 18								
Order No.		50208001	50210001	50212001	50216001	50220001	50312001	50316001	50320001

4-way, 6-way and 8-way multitaps

50400001
QMT-4

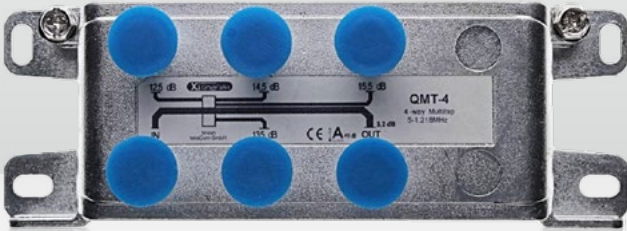

50600001
QMT-6



Parameter	Frequency [MHz]	4-way multitap, staggered tap ports QMT-4	4-way multitap, equal tap ports QMT-4S	6-way multitap, staggered tap ports QMT-6	6-way multitap, equal tap ports QMT-6S	8-way multitap, staggered tap ports QMT-8	8-way multitap, equal tap ports QMT-8S
Through loss [dB] IN – OUT	5 – 10	3,2 ± 0,5	4,2 ± 0,7	6,0 ± 0,5	5,5 ± 0,5	8,5 ± 0,5	7,5 ± 0,5
	10 – 65	3,2 ± 0,5	4,2 ± 0,5	6,0 ± 0,5	5,5 ± 0,5	8,5 ± 0,5	7,5 ± 0,5
	65 – 470	3,2 ± 0,5	4,2 ± 0,5	6,0 ± 0,5	5,5 ± 0,5	8,5 ± 0,5	7,5 ± 0,5
	470 – 862	3,2 ± 0,8	4,2 ± 0,6	6,0 ± 0,8	5,5 ± 0,8	8,5 ± 0,8	7,5 ± 0,8
	862 – 1.006	3,2 ± 1,0	4,2 ± 1,0	6,0 ± 1,0	5,5 ± 1,0	8,5 ± 1,0	7,5 ± 1,0
	1.006 – 1.218	3,2 ± 1,5	4,2 ± 1,2	6,0 ± 1,3	5,5 ± 1,3	8,5 ± 1,3	7,5 ± 1,3
Tap loss* [dB] IN – TAP	5 – 10		2 x 11,5/2 x 12,5 ± 0,7		6 x 15,5 ± 0,5		8 x 17,5 ± 0,5
	10 – 65		2 x 11,5/2 x 12,5 ± 0,5		6 x 15,5 ± 0,5		8 x 17,5 ± 0,5
	65 – 470	12,5/13,5	2 x 11,5/2 x 12,5 ± 0,5	12,5/13,5	6 x 15,5 ± 0,5	12,5/13,5	8 x 17,5 ± 0,5
	470 – 862	14,5/15,5	2 x 11,5/2 x 12,5 ± 0,6	14,5/15,5	6 x 15,5 ± 0,8	16,5/17,5	8 x 17,5 ± 0,8
	862 – 1.006		2 x 11,5/2 x 12,5 ± 1,0	16,5/17,5	6 x 15,5 ± 1,0	18,5/19,5	8 x 17,5 ± 1,0
	1.006 – 1.218		2 x 11,5/2 x 12,5 ± 1,2		6 x 15,5 ± 1,2		8 x 17,5 ± 1,2
Isolation [dB typ.]	5 – 10	> 42	> 40	> 42	> 42	> 42	> 42
	10 – 65	> 42	> 40	> 42	> 42	> 42	> 42
	65 – 470	> 38	> 36	> 38	> 38	> 38	> 38
	470 – 862	> 36	> 34	> 36	> 36	> 36	> 36
	862 – 1.006	> 32	> 32	> 32	> 32	> 32	> 32
	1.006 – 1.218	> 30	> 30	> 30	> 30	> 30	
Directivity [dB typ.] OUT – TAP	5 – 10	> 32	> 30	> 35	> 32	> 35	> 35
	10 – 65	> 32	> 30	> 35	> 32	> 35	> 35
	65 – 470	> 30	> 25	> 30	> 30	> 30	> 30
	470 – 862	> 25	> 25	> 25	> 26	> 28	> 26
	862 – 1.006	> 22	> 25	> 23	> 24	> 26	> 24
	1.006 – 1.218	> 20	> 23	> 22	> 22	> 24	
Dimensions [mm]		133 x 46,5 x 38				155 x 46,5 x 38	
Order No.		50400001	50405001	50600001	50605001	50800001	50805001

* Tap port tolerances: ± 1,0 dB (5 – 1.006 MHz); ± 1,2 dB (1.006 – 1.218 MHz)



50405001
QMT-4S



50800001
QMT-8



50605001
QMT-6S



50805001
QMT-8S

Subject to technical changes!

"Signia" taps and splitters

1-way and 2-way taps

84020110
SiT 1-10



84020220
SiT 2-20



- Frequency range 5 – 1.300 MHz
- Nickel-tin plated brass connectors lead to a minimum failure rate
- Literally maintenance-free, creating a unique OPEX advantage
- Field proven! No lose cable connectors as the Signia connector is temperature- and corrosion-resistant
- Designed for DOCSIS® 3.1

- The Signia product series contains ferrite cores, which are protected against unwanted strong signals and can be driven above their linear range of operation at high power
- Protected against dust & humidity
- Screening factor Class A

Parameter	Frequency [MHz]	1-way taps							
		SiT-1-6	SiT-1-8	SiT-1-10	SiT-1-12	SiT-1-16	SiT-1-20	SiT-1-24	SiT-1-30
Tap loss [dB typ.] IN – TAP	10 – 1.300	6,6 (± 0,6)	8,3 (± 0,6)	10,2 (± 0,6)	12,1 (± 0,6)	16,0 (± 0,6)	20,0 (± 0,6)	23,9 (± 0,6)	30,2 (± 0,6)
Through loss [dB typ.] IN – OUT	10 – 470	2,3	1,7	1,0	0,7	0,6	0,6	0,6	0,6
	470 – 862	2,8	2,1	1,4	1,0	0,8	0,8	0,8	0,8
	862 – 1.006	3,0	2,4	1,8	1,2	1,0	1,0	1,0	1,0
	1.006 – 1.300	3,1	2,8	2,4	1,8	1,6	1,6	1,3	1,3
Directivity typ./min. [dB] TAP – OUT	10 – 470	27/22	27/22	33/24	30/24	36/28	36/28	36/28	40/28
	470 – 862	22/20	23/20	29/21	29/22	30/23	32/24	35/26	38/28
	862 – 1.006	22/20	22/20	25/20	25/21	25/22	27/22	30/24	36/25
1.006 – 1.300	22/20	22/20	25/20	25/20	25/21	28/21	30/21	35/23	
Dimensions [mm]		65 x 50 x 16							
Order No.		84020106	84020108	84020110	84020112	84020116	84020120	84020124	84020130

Parameter	Frequency [MHz]	2-way taps						
		SiT-2-8	SiT-2-10	SiT-2-12	SiT-2-16	SiT-2-20	SiT-2-24	SiT-2-28
Tap loss [dB typ.] IN – TAP	10 – 1.300	8,5 (± 0,8)	10,2 (± 0,8)	12,4 (± 0,8)	16,3 (± 0,8)	20,0 (± 0,8)	24,0 (± 0,8)	28,0 (± 0,8)
Through loss [dB typ.] IN – OUT	10 – 470	3,2	1,9	1,2	1,1	1,1	1,1	1,1
	470 – 862	3,5	2,7	1,7	1,4	1,4	1,4	1,4
	862 – 1.006	3,7	3,2	2,1	1,6	1,6	1,6	1,6
	1.006 – 1.300	3,9	3,8	2,4	2,1	2,1	2,1	2,1
Directivity typ./min. [dB] TAP – OUT	10 – 470	35/26	35/26	36/26	38/26	42/28	44/30	44/30
	470 – 862	30/22	30/23	30/23	30/23	35/24	37/25	37/25
	862 – 1.006	24/21	27/21	28/21	29/22	31/22	33/24	33/24
	1.006 – 1.300	24/20	27/20	27/20	27/20	27/20	29/22	29/22
Isolation typ./min. [dB] TAP – TAP	10 – 470	31/25	35/29	40/32	45/34	60/35	64/35	64/35
	470 – 862	31/22	34/27	38/30	38/34	52/35	60/35	60/35
	862 – 1.006	29/21	32/26	36/28	36/32	46/33	51/35	51/35
	1.006 – 1.300	27/21	31/22	34/25	36/28	43/31	49/34	49/34
Dimensions [mm]		109 x 50 x 16						
Order No.		84020208	84020210	84020212	84020216	84020220	84020224	84020228

3-way to 8-way taps and splitters

84148008
SiS 08

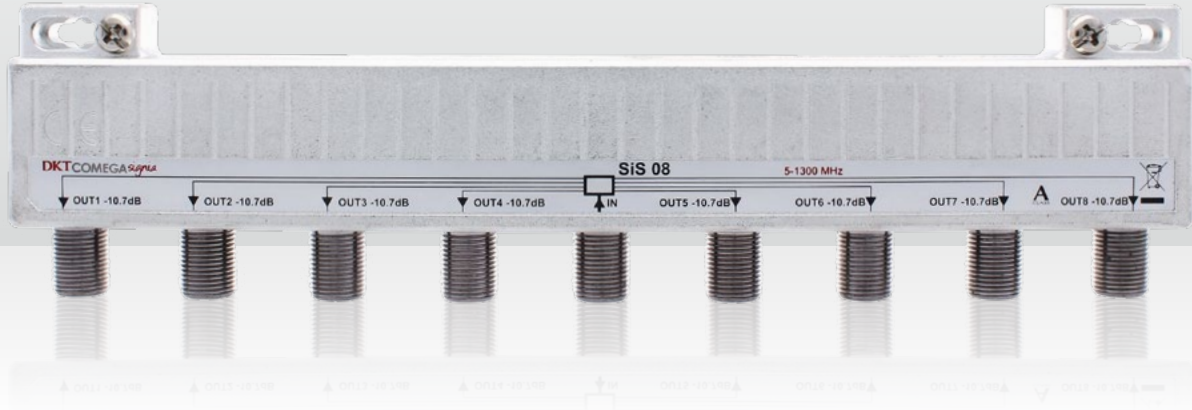

KLASSE
A
CLASS

Parameter	Frequency [MHz]	3-way taps				4-way taps			
		SiT-3-16	SiT-3-20	SiT-4-12s	SiT-4-16s	SiT-4-24s	SiT-2-24	SiT-4-28s	
Tap loss [dB typ.] IN – TAP	10 – 1.300	16,1 (± 0,8)	20,1 (± 0,8)	12,4 (± 0,8)	16,2 (± 0,8)	20,0 (± 0,8)	24,0 (± 0,8)	28,0 (± 0,8)	
	10 – 470	2,0	1,2	3,7	2,7	1,5	1,5	1,5	
Through loss [dB typ.] IN – OUT	470 – 862	1,9	1,5	3,8	2,7	1,8	1,8	1,8	
	862 – 1.006	2,2	1,7	4,3	2,9	2,1	2,1	2,1	
	1.006 – 1.300	2,7	2,3	5,1	3,7	2,7	2,7	2,7	
Directivity typ./min. [dB] TAP – OUT	10 – 470	35/24	44/28	32/24	34/24	40/24	43/25	43/25	
	470 – 862	32/22	33/22	31/22	31/21	33/21	40/24	40/24	
	862 – 1.006	28/21	29/21	27/20	27/21	29/21	33/22	33/22	
	1.006 – 1.300	25/20	25/20	25/20	25/20	27/20	29/20	29/20	
Isolation typ./min. [dB] TAP – TAP	10 – 470	50/34	59/34	48/34	50/36	52/38	54/38	54/38	
	470 – 862	45/32	51/32	43/32	45/34	47/36	49/36	49/36	
	862 – 1.006	41/32	44/32	40/30	42/32	45/34	47/34	47/34	
	1.006 – 1.300	37/30	42/30	38/28	40/30	43/32	45/32	45/32	
Dimensions [mm]		109 x 50 x 16				131 x 50 x 16			
Order No.		84148316	84148320	84148430	84148431	84148432	84148433	84148434	

Parameter	Frequency [MHz]	Internally terminated 4-way taps		Internally terminated 6-way tap	Internally terminated 8-way tap
		SiTT-4-10	SiTT-4-12	SiTT-6-14	SiTT-8-15
Tap loss [dB typ.] IN – TAP	10 – 1.300	10,2 (± 0,9)	12,3 (± 0,9)	14,1 (± 0,8)	15,8 (± 1,1)
	10 – 470	40/30	43/32	40/34	42/36
Isolation typ./min. [dB] TAP – TAP	470 – 862	34/30	36/32	40/32	40/32
	862 – 1.006	32/28	34/30	38/30	40/30
	1.006 – 1.300	30/26	32/28	34/28	37/28
Dimensions [mm]		109 x 50 x 16		196 x 50 x 16	196 x 50 x 16
Order No.		84148410	84148411	84148614	84148815

Parameter	Frequency [MHz]	2-way splitter	3-way splitter	3-way splitter, asymmetric	4-way splitter	6-way splitter	8-way splitter
		SiS-02	SiS-03	SiS-03A	SiS-04	SiS-06	SiS-08
Through loss [dB typ.] IN – OUT	10 – 470	3,3	5,2	3,3/6,6	6,6	8,4	10,1
	470 – 862	3,5	5,6	3,7/7,0	7,1	9,0	10,7
	862 – 1.006	3,7	5,8	3,8/7,3	7,5	9,4	11,2
	1.006 – 1.300	4,0	6,2	4,2/7,8	7,9	9,9	11,9
Isolation typ./min. [dB] OUT – OUT	10 – 470	34/28	32/25	32/24	35/24	33/23	33/24
	470 – 862	30/23	30/22	30/24	30/22	28/20	32/22
	862 – 1.006	29/22	26/20	30/24	30/20	28/20	31/20
	1.006 – 1.300	24/20	23/18	28/21	30/20	28/18	30/20
Dimensions [mm]		65 x 50 x 16	109 x 50 x 16		109 x 50 x 16	196 x 50 x 16	196 x 50 x 16
Order No.		84148002	84148003	84148005	84148004	84148006	84148008

Outdoor splitters and taps

1,2 GHz power inserter, splitters and couplers



52703000
SPLRE-03



52710800
TPLRE-1-8



- Watertight aluminium alloy housing with PU coating (IP68)
- Waterproof condition 15 PSI
- AC current path with jumpers can be switched to all outputs
- High screening factor Class A +10 dB
- All connections are 5/8"-threads

- Power rating max. 15 A, 90 VAC
- Hum modulation distance at 10 A with 70 dB average
- Surge protection 1 kV 1,2/50 µs
- Operating temperature range: -40°C ... +60°C
- Mounting angle not included (Order No. 52999000)

Parameter	Frequency [MHz]	Power inserter	2-way splitter	3-way splitter		SPLRE-03E
		PIRE-01 IN – OUT	SPLRE-02 IN – OUT 1; 2	SPLRE-03 IN – OUT 1	SPLRE-03 IN – OUT 2; 3	
Through loss [dB]	5 – 10	0,7	4,1	4,1	7,4	7,0
	10 – 65	0,7	4,1	4,1	7,4	6,5
	65 – 300	0,7	4,3	4,3	7,5	6,5
	300 – 550	0,7	4,5	4,5	7,6	7,0
	550 – 750	1,0	4,6	4,6	7,7	7,3
	750 – 862	1,3	4,7	4,7	7,8	7,5
	862 – 1.006	1,3	4,8	4,8	8,0	8,5
	1.006 – 1.218	1,4	5,5	6,0	9,5	9,0
		Power max. 20 A, 90 VAC				
Return loss [dB min.]	5 – 10	17	16		16	16
	10 – 47	18	18		18	16
	47 – 300	18*	18*		18*	18*
	300 – 1.218	16	16		16	16
Isolation [dB min.]	5 – 10	75	20		21	18
	10 – 550	60	25		22	22
	550 – 750	60	25		21	22
	750 – 862	50	22		20	21
	862 – 1.006	50	20		20	20
	1.006 – 1.218	45	18		20	20
Dimensions [mm]		138 x 124 x 72				
Order No.		52701000	52702000	52703000		52703500

Parameter	Frequency [MHz]	1-way directional coupler		
		TPLRE-1-8	TPLRE-1-12	TPLRE-1-16
Through loss [dB]	5 – 10	1,8	1,2	1,3
	10 – 65	1,6	1,2	1,3
	65 – 550	2,0	1,5	1,3
	550 – 750	2,5	1,5	1,3
	750 – 862	2,9	1,8	1,6
	862 – 1.006	3,1	2,2	1,6
Tap loss [dB max.]	1.006 – 1.218	3,3	2,7	2,2
	5 – 1.006	9,5	13,0	17,0
Return loss [dB min.]	1.006 – 1.218	10,2	13,5	17,5
	5 – 10	16	16	16
	10 – 47	16	18	18
	47 – 300	18*	18*	18*
Directivity [dB min.]	300 – 1.218	16	16	16
	5 – 10	18	19	21
	10 – 65	28	23	25
	65 – 300	28	25	30
	300 – 550	25	25	25
	550 – 750	21	20	20
750 – 1.218	18	18	20	
Dimensions [mm]		138 x 124 x 72		
Order No.		52710800	52711200	52711600

* At 47 MHz -1,5 dB/Oct

1,2 GHz 2-way outdoor taps



52722040
MTRE-122-4



52722320
MTRE-122-32

■ KLASSE
A
+ 10 dB
CLASS

- Watertight aluminium alloy housing with PU coating (IP65), when connecting waterproof and dustproof F connectors to the F ports (e.g. Cabelcon Hardline F connectors) IP 68
- Waterproof condition 15 PSI
- NiSn65 alloy coated, watersealed F-female connectors
- AC/RF bypass in the loop (IN – OUT) in case of a removed faceplate max. 12 A, 65 VAC

- High screening factor Class A +10 dB
- Terminals: Tap F-female; IN/OUT 5/8"
- Hum modulation distance at 10 A with 70 dB average
- Surge protection 1 kV 1,2/50 µs
- Operating temperature range: -40°C ... +60°C
- Mounting angle not included (Order No. 52999000)
- SA type on request

Parameter	Frequency [MHz]	MTRE-122-4		MTRE-122-8		MTRE-122-11		MTRE-122-14		MTRE-122-17	
Through loss [dB]	5 – 65	–	–	3,6	–	1,6	–	1,1	–	1,1	–
	65 – 300	–	–	4,0	–	1,8	–	1,3	–	1,2	–
	300 – 550	–	–	4,7	–	2,5	–	1,9	–	1,7	–
	550 – 750	–	–	5,0	–	2,7	–	2,1	–	1,8	–
	750 – 862	–	–	5,0	–	3,0	–	2,3	–	2,0	–
	862 – 1.006	–	–	5,1	–	3,1	–	2,4	–	2,1	–
1.006 – 1.218	–	–	5,3	–	3,3	–	2,6	–	2,3	–	
Tap loss [dB max.]	5 – 862	5,0	–	9,0	–	12,0	–	15,0	–	18	–
	862 – 1.218	5,5	–	9,5	–	12,5	–	15,5	–	18,5	–
Return loss [dB min.]	5 – 10	16	–	16	–	15	–	16	–	16	–
	10 – 47	18	–	18	–	18	–	18	–	18	–
	47 – 300	18*	–	18*	–	18*	–	18*	–	18*	–
	300 – 1.006	16	–	16	–	16	–	16	–	16	–
	1.006 – 1.218	14	–	14	–	14	–	14	–	14	–
Isolation [dB min.]	5 – 10	–	20	18	20	22	20	24	20	27	22
	10 – 65	–	26	27,5	26	29	26	30,5	26	32	26
	65 – 862	–	24	25,5	24	27	24	28,5	24	30	24
	862 – 1.218	–	22	23,5	22	25	22	26,5	22	28	22
Dimensions [mm]	95 x 98,5 x 76										
Order No.	52722040		52722080		52722110		52722140		52722170		

Parameter	Frequency [MHz]	MTRE-122-20		MTRE-122-23		MTRE-122-26		MTRE-122-29		MTRE-122-32	
Through loss [dB]	5 – 65	0,8	–	0,8	–	0,7	–	0,7	–	0,7	–
	65 – 300	0,9	–	0,9	–	0,9	–	0,8	–	0,8	–
	300 – 550	1,3	–	1,3	–	1,3	–	1,2	–	1,2	–
	550 – 750	1,5	–	1,5	–	1,4	–	1,3	–	1,3	–
	750 – 862	1,8	–	1,7	–	1,7	–	1,4	–	1,4	–
	862 – 1.006	1,9	–	1,8	–	1,8	–	1,5	–	1,5	–
1.006 – 1.218	2,1	–	2,0	–	2,0	–	1,7	–	1,7	–	
Tap loss [dB max.]	5 – 862	21	–	24	–	27	–	30	–	33	–
	862 – 1.218	21,5	–	24,5	–	27,5	–	30,5	–	33,5	–
Return loss [dB min.]	5 – 10	16	–	16	–	16	–	16	–	16	–
	10 – 47	18	–	18	–	18	–	18	–	18	–
	47 – 300	18*	–	18*	–	18*	–	18*	–	18*	–
	300 – 1.006	16	–	16	–	16	–	16	–	16	–
	1.006 – 1.218	14	–	14	–	14	–	14	–	14	–
Isolation [dB min.]	5 – 10	30	25	30	25	34	25	38	25	38	25
	10 – 65	33,5	26	35	26	36,5	26	38	26	38	26
	65 – 862	31,5	24	33	24	34,5	24	36	24	36	24
	862 – 1.218	29,5	22	31	22	32,5	22	34	22	34	22
Dimensions [mm]	95 x 98,5 x 76										
Order No.	52722200		52722230		52722260		52722290		52722320		

* At 47 MHz -1,5 dB/Oct

1,2 GHz 4-way outdoor taps



52722080
MTRE-124-8



52724260
MTRE-124-26

■ KLASSE
A
+10 dB
■ CLASS

- Watertight aluminium alloy housing with PU coating (IP65), when connecting waterproof and dustproof F connectors to the F ports (e.g. Cabelcon Hardline F connectors) IP 68
- Waterproof condition 15 PSI
- NiSn65 alloy coated watersealed F-female connectors
- AC/RF bypass in the loop (IN – OUT) in case of a removed faceplate max. 12 A, 65 VAC

- High screening factor Class A +10 dB
- Terminals: Tap F-female; IN/OUT 5/8"
- Hum modulation distance at 10 A with 70 dB average
- Surge protection 1 kV 1,2/50 µs
- Operating temperature range: -40°C ... +60°C
- Mounting angle not included (Order No. 52999000)
- SA type on request

Parameter	Frequency [MHz]	MTRE-124-8		MTRE-124-11		MTRE-124-14		MTRE-124-17		MTRE-124-20	
Through loss [dB]	5 – 65	–	–	3,6	–	1,6	–	1,1	–	1,1	–
	65 – 300	–	–	4,0	–	1,8	–	1,3	–	1,2	–
	300 – 550	–	–	4,7	–	2,5	–	1,9	–	1,7	–
	550 – 750	–	–	5,0	–	2,7	–	2,1	–	1,8	–
	750 – 862	–	–	5,0	–	3,0	–	2,3	–	2,0	–
	862 – 1.006	–	–	5,1	–	3,1	–	2,4	–	2,1	–
Tap loss [dB max.]	1.006 – 1.218	–	–	5,3	–	3,3	–	2,6	–	1,3	–
	5 – 862	9	–	12	–	15	–	18	–	21	–
Return loss [dB min.]	862 – 1.218	9,5	–	12,5	–	15,5	–	18,5	–	21,5	–
	5 – 10	16	–	15	–	15	–	15	–	16	–
	10 – 47	18	–	18	–	18	–	18	–	18	–
	47 – 300	18*	–	18*	–	18*	–	18*	–	18*	–
	300 – 1.006	15	–	15	–	15	–	15	–	15	–
Isolation [dB min.]	1.006 – 1.218	14	–	14	–	14	–	14	–	14	–
	5 – 10	–	Out-Tap	Tap-Tap	Out-Tap	Tap-Tap	Out-Tap	Tap-Tap	Out-Tap	Tap-Tap	Out-Tap
	10 – 65	–	20	20	20	20	21	20	22	20	27
	65 – 862	–	26	29	26	26	30,5	26	32	26	33,5
Dimensions [mm]	862 – 1.218	–	24	27	24	24	28,5	24	30	24	31,5
		–	22	25	22	22	26,5	22	28	22	29,5
Order No.		52724080		52724110		52724140		52724170		52724200	

Parameter	Frequency [MHz]	MTRE-124-23		MTRE-124-26		MTRE-124-29		MTRE-124-32	
Through loss [dB]	5 – 65	0,8	–	0,8	–	0,7	–	0,7	–
	65 – 300	0,9	–	0,9	–	0,9	–	0,8	–
	300 – 550	1,3	–	1,3	–	1,3	–	1,2	–
	550 – 750	1,5	–	1,5	–	1,4	–	1,3	–
	750 – 862	1,8	–	1,7	–	1,7	–	1,4	–
	862 – 1.006	1,9	–	1,8	–	1,8	–	1,5	–
Tap loss [dB max.]	1.006 – 1.218	2,1	–	2,0	–	2,0	–	1,7	–
	5 – 862	24	–	27	–	30	–	33	–
Return loss [dB min.]	862 – 1.218	24,5	–	27,5	–	30,5	–	33,5	–
	5 – 10	16	–	16	–	16	–	16	–
	10 – 47	18	–	18	–	18	–	18	–
	47 – 300	18*	–	18*	–	18*	–	18*	–
	300 – 1.006	15	–	15	–	15	–	15	–
Isolation [dB min.]	1.006 – 1.218	14	–	14	–	14	–	14	–
	5 – 10	30	Out-Tap	Tap-Tap	Out-Tap	Tap-Tap	Out-Tap	Tap-Tap	Out-Tap
	10 – 65	35	20	20	34	20	35	20	36
	65 – 862	33	26	26	36,5	26	38	26	39,5
Dimensions [mm]	862 – 1.218	33	24	34,5	24	36	24	37,5	24
		31	22	32,5	22	34	22	35,5	22
Order No.		52724230		52724260		52724290		52724320	

* At 47 MHz -1,5 dB/Oct

1,2 GHz 8-way outdoor taps



52728110
MTRE-128-11



52728290
MTRE-128-29

■ KLASSE
A
+10 dB
CLASS

- Watertight aluminium alloy housing with PU coating (IP65), when connecting waterproof and dustproof F connectors to the F ports (e.g. Cabelcon Hardline F connectors) IP 68
- Waterproof condition 15 PSI
- NiSn65 alloy coated watersealed F-female connectors
- AC/RF bypass in the loop (IN – OUT) in case of a removed faceplate max. 12 A, 65 VAC

- High screening factor Class A +10 dB
- Terminals: Tap F-female; IN/OUT 5/8"
- Hum modulation distance at 10 A with 70 dB average
- Surge protection 1 kV 1,2/50 µs
- Operating temperature range: -40°C ... +60°C
- Mounting angle not included (Order No. 52999000)
- SA type on request

Parameter	Frequency [MHz]	MTRE-128-11		MTRE-128-14		MTRE-128-17		MTRE-128-20	
Through loss [dB]	5 – 65	–	–	3,6	–	1,6	–	1,1	–
	65 – 300	–	–	4,0	–	1,8	–	1,3	–
	300 – 550	–	–	4,7	–	2,5	–	1,9	–
	550 – 750	–	–	5,0	–	2,7	–	2,1	–
	750 – 862	–	–	5,0	–	3,0	–	2,3	–
	862 – 1.006	–	–	5,1	–	3,1	–	2,4	–
Tap loss [dB max.]	1.006 – 1.218	–	–	5,3	–	3,6	–	2,6	–
	5 – 862	12	–	15	–	18	–	21	–
Return loss [dB min.]	862 – 1.218	12,5	–	15,5	–	18,5	–	21,5	–
	5 – 10	16	–	16	–	16	–	16	–
	10 – 47	18	–	18	–	18	–	18	–
	47 – 300	18*	–	18*	–	18*	–	18*	–
	300 – 1.006	16	–	16	–	16	–	16	–
Isolation [dB min.]	1.006 – 1.218	14	–	14	–	14	–	14	–
	5 – 10	–	22	22	22	22	22	26	22
	10 – 65	–	26	30,5	26	32	26	33,5	26
	65 – 862	–	24	28,5	24	30	24	31,5	24
	862 – 1.006	–	22	26,5	22	28	22	29,5	22
Dimensions [mm]	1.006 – 1.218	–	20	24,5	20	26	20	27,5	20
		117,5 x 145,5 x 78							
Order No.		52728110		52728140		52728170		52728200	

Parameter	Frequency [MHz]	MTRE-128-23		MTRE-128-26		MTRE-128-29		MTRE-128-32	
Through loss [dB]	5 – 65	1,1	–	0,8	–	0,8	–	0,7	–
	65 – 300	1,2	–	0,9	–	0,9	–	0,9	–
	300 – 550	1,7	–	1,3	–	1,3	–	1,3	–
	550 – 750	1,8	–	1,5	–	1,5	–	1,4	–
	750 – 862	2,0	–	1,8	–	1,7	–	1,7	–
	862 – 1.006	2,1	–	1,9	–	1,8	–	1,8	–
Tap loss [dB max.]	1.006 – 1.218	2,3	–	2,1	–	2,0	–	2,0	–
	5 – 862	24	–	27	–	30	–	33	–
Return loss [dB min.]	862 – 1.218	24,5	–	27,5	–	30,5	–	33,5	–
	5 – 10	16	–	16	–	16	–	16	–
	10 – 47	18	–	18	–	18	–	18	–
	47 – 300	18*	–	18*	–	18*	–	18*	–
	300 – 1.006	16	–	16	–	16	–	16	–
Isolation [dB min.]	1.006 – 1.218	14	–	14	–	14	–	14	–
	5 – 10	33	22	35	22	40	22	40	22
	10 – 65	35	26	36,5	26	38	26	39,5	26
	65 – 862	33	24	34,5	24	36	24	37,5	24
	862 – 1.006	31	22	32,5	22	34	22	35,5	22
Dimensions [mm]	1.006 – 1.218	29	20	30,5	20	32	20	33,5	20
		117,5 x 145,5 x 78							
Order No.		52728230		52728260		52728290		52728320	

* At 47 MHz -1,5 dB/Oct

Remote power filters and equalizers

Remote power rating high pass filters in modular concept



- Flexible configuration of high pass filter via plug-in modules DCM-HFxx
- AC/RF bypass switch in the loop for uninterrupted service in case of a removed faceplate, e.g. to change the plug-in module
- Power passing to the loop (IN – OUT) by 12 A at 65/90 VAC
- Hum modulation distance at 10 A/90 VAC -60 dB average
- Surge protection 6 kV 1,2/50 μ s

- Watertight aluminium alloy housing with PU coating (IP65)
- Waterproof condition 15 PSI
- All connections are 5/8" threads
- 100 dB min. RFI isolation
- Mounting angle not included (Order No. 52999000)

Parameter	Plug-in module high pass filter DCM-HF30	Plug-in module high pass filter DCM-HF85
Pass band [MHz]	30 – 1.000	84 – 1.000
Through loss [dB]	$\leq 1,5 \pm 0,5$	$\leq 1,5 \pm 0,5$
Stop band [MHz]	5 – 25	5 – 65
Rejection [dB]	> 50	> 50
Return loss [dB]	> 16	> 16
Dimensions [mm]	144 x 118 x 75	
Order No.	57863000	57868500

Assembling of tap modules into the FSP housing



1. Remove the cover from the housing (Order No. 57860000).



2. Insert the DCM module as shown into the plug-in socket. The direction of the modules is guided by a guide rail on the plug-in socket.



3. Mount the cover onto the housing and paste the matching sticker for identification of the high pass filter onto the label.

Uninterrupted AC & RF transmission in the loop

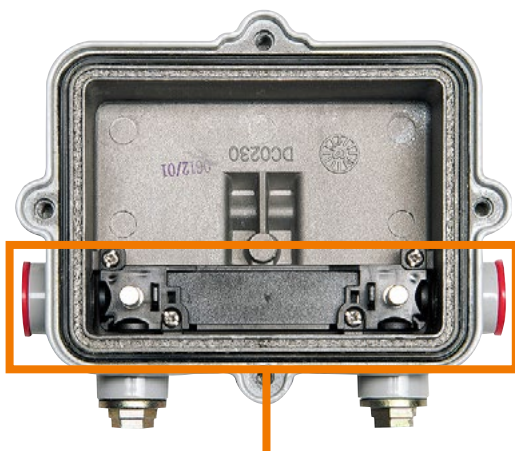

An integrated power passing bar between in- and output provides an uninterrupted AC and RF signal forwarding to the downstream network.

Remote power rating line equalizer in modular concept



52711806
 DCM-65EQ-6G



52711800
 Basic housing
 FSP-DCM-EQ



- Flexible configuration of the equalizer via plug-in modules DCM-65EQ-xx
- AC/RF bypass switch in the loop for uninterrupted service in case of a removed faceplate, e.g. to change the plug-in module
- Power passing to the loop (IN – OUT) by 12 A at 65/90 VAC
- Hum modulation distance at 10 A/90 VAC -70 dB average
- Surge protection 6 kV 1,2/50 μ s
- Watertight aluminium alloy housing with PU coating (IP68)
- Waterproof condition 15 PSI
- All connections are 5/8" threads
- 100 dB min. RFI isolation
- Mounting angle not included (Order No. 52999000)

Parameter	Frequency [MHz]	DCM-65EQ-3G	DCM-65EQ-6G	DCM-65EQ-9G	DCM-65EQ-12G
Through loss [dB]	5 – 60	0,9 \pm 0,6	0,9 \pm 0,6	0,9 \pm 0,6	0,9 \pm 0,6
	60 – 65	1,8 \pm 0,7	1,8 \pm 0,7	1,8 \pm 0,7	1,8 \pm 0,7
	85 – 1.006	5 \pm 0,75 - 2 \pm 0,75	8 \pm 0,75 - 2 \pm 0,75	11 \pm 0,75 - 2 \pm 0,75	14,5 \pm 0,75 - 2 \pm 0,75
	1.006 – 1.218	2 \pm 0,75 - 1,8 \pm 1	2 \pm 0,75 - 1,8 \pm 1	2 \pm 0,75 - 1,8 \pm 1	2 \pm 0,75 - 1,8 \pm 1
Return loss [dB]		> 16	> 16	> 16	> 16
Order No.		52711803	52711806	52711809	52711812

Parameter	Frequency [MHz]	FSP-DCM-EQ
Through loss with removed faceplate [dB max.]	5 – 1.006	0,5
	1.006 – 1.218	1
Dimensions [mm]		144 x 118 x 75
Order No.		52711800

Assembling of tap modules into the FSP housing



1. Remove the cover from the housing (Order No. 57860000).
2. Insert the DCM module as shown into the plug-in socket. The direction of the modules is guided by a guide rail on the plug-in socket.
3. Mount the cover onto the housing and paste the matching sticker for identification of the high pass filter onto the label.

Uninterrupted AC & RF transmission in the loop



An integrated power passing bar between in- and output provides an uninterrupted AC and RF signal forwarding to the downstream network.

Shrink sleeves

Shrink sleeves, repair gaskets and house leading-in shrink sleeves

42455000
SHE 14-8/800 (MD 1)



Shrink sleeves

Parameter	BK-CS 25-7/170	BK-CS 34-7/130	BK-CS 32-8/210	BK-CS 28-6/1000	BK-CS 38-10/1000
Length A [mm]	170	130	210	1.000	1.000
Inner diameter B [mm]	Before shrinking	25	34	28	38
	After shrinking	7	7	8	6
Cleaning cloth and flame protection winding included?	Yes	No	Yes	No	No
Order No.	43027000	43030000	43032000	43023500	43024000

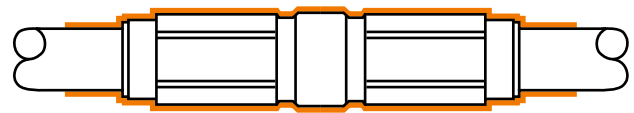
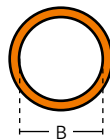
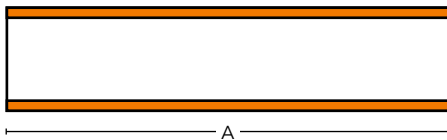

Repair gaskets

For a simple, safe, and fast repair of defective sheathing of plastic-insulated cables and wires.

Suited for	Outdoor, underground and indoor cabling
Internal pressure density	Up to 0,15 Mpa (1,5 bar)
Wall thickness (shrunk)	2,3 mm
Correct length of gasket	At least twice the cable or wire diameter, to ensure sufficient overlap on both sides of the damaged part

Parameter	RM 47-13/250	
Length A [mm]	200	
Cable diameter [mm]	Minimum	15
	Maximum	46
Inner diameter B [mm]	Before shrinking	47
	After shrinking	13
Order No.	43026000	



House leading-in shrink sleeves

For a professional cable lead-in into buildings. Cables led through walls of up to 500 mm wall thickness can be effectively sealed by house lead-in shrink sleeves.

Tested and field-proven according DBP TL-Nr. 736 840 TV 2 standards. Waterproof up to 1 bar; gasproof up to 0,2 bar.

Parameter	SHE 14-8/800 (MD 1)	SHE 26-12/800 (MD 2)	
Length [mm]	800	800	
Cable diameter [mm]	Minimum	8	
	Maximum	14	26
Wall thickness [mm]	Maximum	500	500
Diameter of drilled hole [mm]	Minimum	40	55
	Order No.	42455000	42465000

Snap-On wire markers

STD Snap-On wire markers and STD/STB applicators

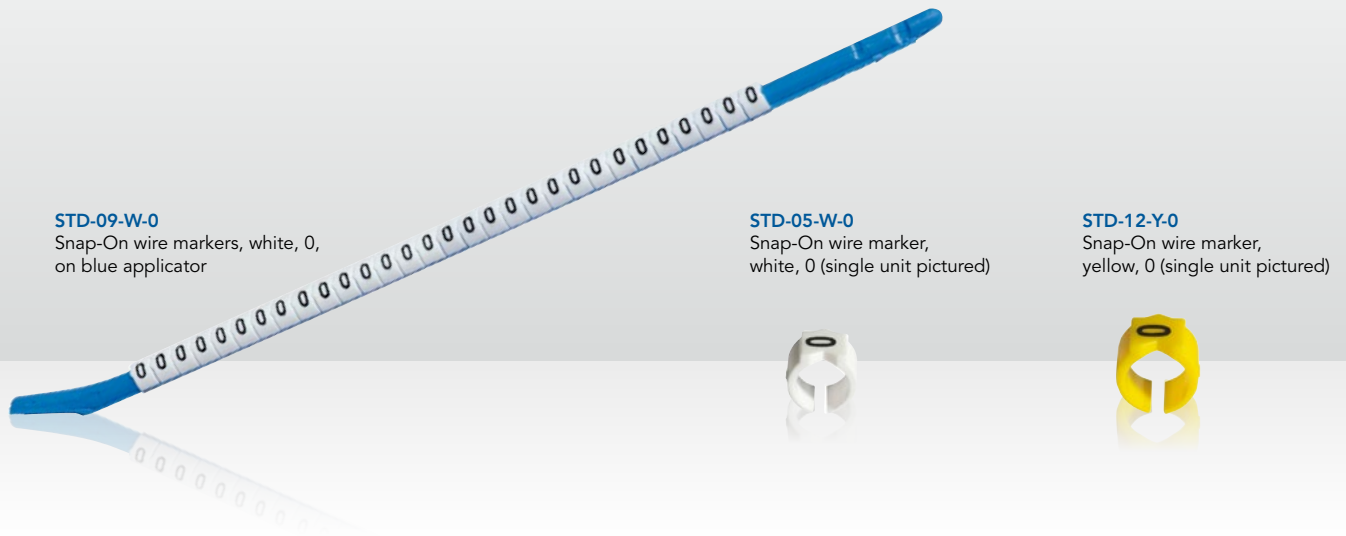

STD-09-W-0
Snap-On wire markers, white, 0,
on blue applicator

STD-05-W-0
Snap-On wire marker,
white, 0 (single unit pictured)

STD-12-Y-0
Snap-On wire marker,
yellow, 0 (single unit pictured)

STD Snap-On wire markers

For simple and permanent marking or assignment of cables, wires, leads and cores after their installation.

Easy installation: The "wand" applicator is pushed over the marking line and the marker with your thumb over it. The marker opens and firmly grips the cable. Due to the particularly high material tension, the markers are non-slip.

Features and benefits

- Made of high-quality, extremely elastic polyoxymethylene
- Resistant against oil, cleaning agents, fuels and alkaline solutions
- Guarantees strength, dimensional stability, low moisture absorption and resistance to chemicals
- Halogen-free
- No stress crack generation
- Highest resilience
- Good sliding behaviour
- Operating temperature range -40°C ... +106°C

Snap-On wire markers

Description	Color code	Color of applicator	Amount	Suitable for cable outer diameter
STD-01	Y (yellow) or W (white)	green	300 markers on 10 applicators	1,00 – 1,40 mm
STD-03	Y (yellow) or W (white)	green	300 markers on 10 applicators	1,90 – 2,65 mm
STD-05	Y (yellow) or W (white)	natural	300 markers on 10 applicators	2,30 – 3,00 mm
STD-06	Y (yellow) or W (white)	red	300 markers on 10 applicators	2,60 – 3,50 mm
STD-09	Y (yellow) or W (white)	blue	300 markers on 10 applicators	3,25 – 4,50 mm
STD-12	Y (yellow) or W (white)	yellow	300 markers on 10 applicators	4,50 – 6,00 mm
STD-15	Y (yellow) or W (white)	–	50 markers without applicator	5,80 – 8,00 mm

Applicators

Description	Color of applicator	Use	Packaging unit
STD 15 applicator	orange	for STD-15	5 applicators
STD 17 applicator	orange	for STD-17	5 applicators
STD 21 applicator	grey	for STD-21	2 applicators
STD 24 applicator	grey	for STD-24	2 applicators

Composition of the article name

Example for an order:

STD	-	06	-	W	-	4
Snap-On wire markers		Size		Color (W or Y)		Imprint (digit 4)

We do not have the perfect Snap-On wire markers in our product portfolio yet?

We are happy to produce Snap-On wire markers according to your requirements, even in small quantities!

Connectors

CX3 compression connectors



Parameter	GF-UE-6 (5,1) ULTRAEASE	5/8MU-RG11-CX3 7,5	3,5/12m-RG11-CX3-7,5
For cable type	e.g. Oren HD-113	e.g. Oren HD-163, PRG-11-Cu and PRG-11-DB+	e.g. Belden PRG-11-Cu and PRG-11-DB+
Connector type	F connection	5/8 connection	
Installation	Mounting without special tools	Mounting only with compression tool, please find further information concerning compression tools within our tools catalogue	
Frequency range [MHz]		0,3 – 3.000	
Screening factor [dB]		> 120	
Transfer impedance [mΩ/connector]		< 0,1	
Impedance [Ω]		75	
Temperature range [°C]		-40 ... +100	
Return loss [dB]		> 30	
Order No.	54271000	54269702	54269300

Parameter	Frequency [MHz]	FM-RG11-CX3 7,5	IECF-56-CX3 4,9	IECF-56-CX3 5,1	IECM-56-CX3 4,9	IECM-6-TD-5,1
For cable type		Oren HD-163 and Belden PRG-11-DB+, PRG-11-Cu	Oren HD-103 and Belden H-126-T-00	Oren HD-113	Oren HD-103 and Belden H-126-T-00	Oren HD-113
Connector type		RG11	IEC-Female	IEC-Female	IEC-Male	IEC-Male
Installation						
Length [mm]		44,0	33,5	33,5	33,5	33,5
Connector F-nut		HEX 14				
Frequency range [MHz]				0,3 – 3.000		
Screening factor [dB]	30 – 1.000	> 100	> 90	> 90	> 90	> 85
Transfer impedance [mΩ/connector]		< 2,0	< 0,2	< 0,2	< 0,2	< 2,5
Impedance [Ω]				75		
Temperature range [°C]				-40 ... +100		
Return loss [dB]	0,3 – 1.000	> 30	> 20	> 20	> 20	> 17
Order No.		54266000	54269000	54269200	54268000	54280186

Accessories

Grounding ring RG11/220

Include the RG11-CX3 compression connectors into the local potential equalization, suitable for the compression connectors FM-RG11-CX3 7,5; 3,5/12M-RG11-CX3 7,5; 5/8MU-RG11-CX3 7,5 and IEC14M-RG11-CX3 7,5

Order No.. **60300900**

TrueDrop connectors



Less signal noise, more user-friendliness and better overall reliability thanks to our proprietary, self-centering, conical connector interface, make TrueDrop connectors very adaptable

to a variety of connection conditions, offer a uniform 360-degree contact, eliminate air gaps, reduce damage to the O-ring and counteract the rotation of the sleeve.

Parameter	Frequency [MHz]	F-59-TD SELF INSTALL 3,9 NI	F-6-TD SELF INSTALL 4,9 NI	F-6-TD SELF INSTALL 5,1 NI
For cable type		e.g. Oren HD-083 and Belden H-121-T-00	e.g. Oren HD-103 and Belden H-126-T-00	e.g. Oren HD-113
Type		Self-Install		
Installation		Mounting without special tools		
Frequency range [MHz]		0,3 – 3.000 MHz		
Screening [dB]	30 – 1.000	> 105, Class A++		
Transfer impedance/item [mΩ]	5 – 30	< 0,53	< 0,18	< 0,53
Impedance [Ω]		75		
Operating temperature range [°C]		-40 – +70		
Return loss [dB]	0,3 – 1.000	> 37	> 35	> 36
Order No.		54280121	54280131	54280136

Parameter	Frequency [MHz]	FM-MINI-TD QM 3,1 W/O O-RING	FM-MINI-TD QM 4,0 W/O O-RING	F-MINI-TD QM 4,0 SHORT	FM-MINI-TD QM 4,5 W/O O-RING	F-MINI-TD QM 4,5 SHORT	FM-MINI-TD QM 5,0 W/O O-RING	F-MINI-TD QM 5,0 SHORT
For cable type		e.g. Telass 40	e.g. Oren HD-063 and Belden H-123-B	e.g. Oren HD-063 and Belden H-123-B	e.g. Belden H-123	e.g. Belden H-123	e.g. Belden H-121-T	e.g. Belden H-121-T
Type		Quick Mount™						
Installation		Mounting only with compression tool, please find further information concerning compression tools in our tools catalogue						
Frequency range [MHz]		0,3 – 3.000 MHz						
Screening* [dB]	30 – 1.000	> 93 Class A	> 85 Class A	> 105 Class A++	> 75 Class A	> 85 Class A	> 85 Class A	> 105 Class A++
Transfer impedance/item [mΩ]	5 – 30	< 0,39	< 0,27	< 0,11	< 0,14	< 0,11	< 0,39	< 0,05
Impedance [Ω]		75						
Operating temperature range [°C]		-40 – +70						
Return loss [dB]	0,3 – 1.000	> 37	> 31	> 25	> 28	> 33	> 32	> 28
Order No.		54280201	54280202	54280204	54280206	54280208	54280210	54280212

* Please note that the specified screening depends on the cable used. With high-quality coaxial cables, it is often possible to achieve better values than specified. You can find information on high-quality coaxial cables in our corresponding product category.

54280214
F-59-TD QM
6,0 SHORT

54280220
F-6-TD
QM 7,0

54280221
F-6-TD QM
7,0 W/O
O-RING

54280222
F-6-TD QM
7,0 SHORT
W/O O-RING

54280316
F-59-TD 3,7

54280321
F-59-TD 3,9

54280335
F-59-TD
3,9 HEC

54280341
F-6-TD 4,9

54280346
F-6-TD 5,1



Parameter	Frequency [MHz]	F-59-TD QM 6,0	F-6-TD QM 7,0	F-6-TD QM 7,0 W/O O-RING	F-6-TD QM 7,0 SHORT W/O O-RING
For cable type		e.g. Oren HD-083	e.g. Oren HD-103 and HD-113	e.g. Oren HD-103 and HD-113	e.g. BKS1,1/4,8-90, BKS2050/30
Type		Quick Mount™			
Installation		Mounting only with compression tool, please find further information concerning compression tools in our tools catalogue			
Frequency range [MHz]		0,3 – 3.000 MHz			
Screening [dB]	30 – 1.000	> 105 Class A++	> 130 Class A++	> 130 Class A++	> 105 Class A++
Transfer impedance/item [mΩ]	5 – 30	< 0,07	< 0,09	< 0,09	< 0,14
Impedance [Ω]		75			
Operating temperature range [°C]		-40 – +70			
Return loss [dB]	0,3 – 1.000	> 26	> 29	> 29	> 29
Order No.		54280214	54280220	54280221	54280222

Parameter	Frequency [MHz]	F-59-TD 3,7	F-59-TD 3,9	F-59-TD 3,9 HEC	F-6-TD 4,9	F-6-TD 5,1
For cable type		e.g. Belden H-121-T	e.g. Oren HD-083 and Belden H-121-T-00	CommScope Kabel e.g. F59 HEC-2VV	e.g. Oren HD-103	e.g. BKS1,1/4,8-90, BKS2050/30
Type		Compression				
Installation		Mounting only with compression tool, please find further information concerning compression tools in our tools catalogue				
Frequency range [MHz]		0,3 – 3.000 MHz				
Screening [dB]	30 – 1.000	> 105 Class A++	> 105 Class A++	> 105 Class A++	> 105 Class A++	> 105 Class A++
Transfer impedance/item [mΩ]	5 – 30	< 0,68	< 0,68	< 0,1	< 0,09	< 0,68
Impedance [Ω]		75				
Operating temperature range [°C]		-40 – +70				
Return loss [dB]	0,3 – 1.000	> 32	> 39	> 30	> 39	> 35
Order No.		54280316	54280321	54280335	54280341	54280346

Mounting instructions for F-TrueDrop connectors

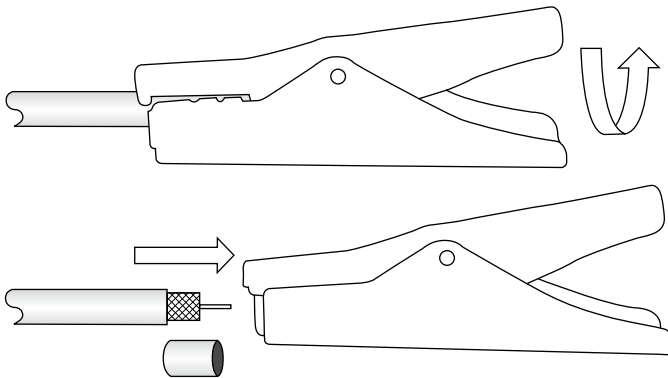

Step 1

Strip the cable.
Cut and remove the outer braid and foil. Leave only the first layer of braid (if needed, adjust cable stripper accordingly). Clean the cable inner and outer conductor with a conductor cleaner or any other appropriate equipment.
For your safety and best results Corning Cabelcon's pre-adjusted Cable Stripper is recommended. Please find further information concerning these tools within our tools catalogue. Don't forget – read the enclosed user instruction before using the tool.

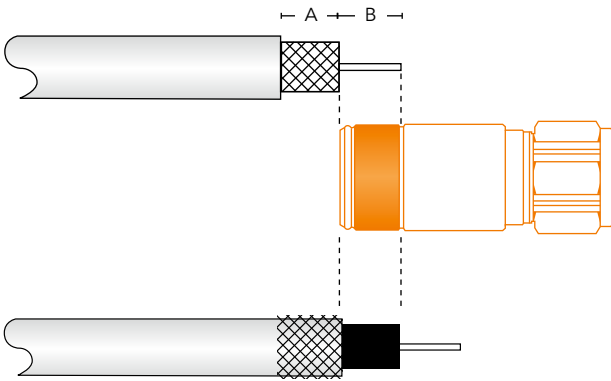

Step 2

Verify stripped dimensions by using the cutting guide on the connector.
A = 6,5 mm (outer conductor)
B = 6,5 – 8,0 mm (inner conductor)

Step 3

Brush/fold exposed braid back over jacket by using a stripping tool brush (if available) or any other nonmetallic brush.

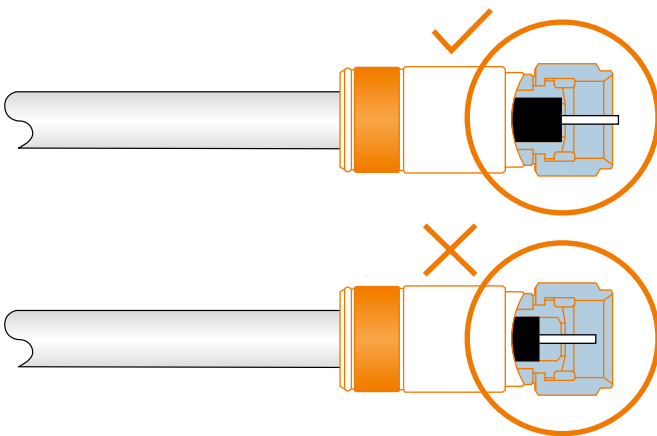

Step 4

Push the connector over the foil, allow the support sleeve to slide between the foil and braid. Press and turn until the dielectric is flush with the support mandrel face.

For better connector and cable grip, a connector mounting and cable rubber grip tool can be used. Please find further information in our tools catalogue.

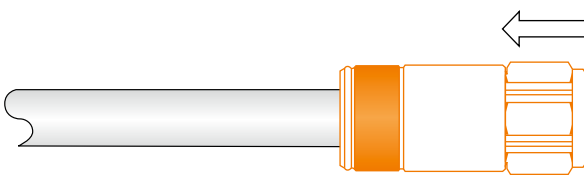

Step 5

Compress the connector by using the recommended compression tool.
Please find further information on compression tools in our tools catalogue.

Mounting instructions for FM QM-TrueDrop connectors

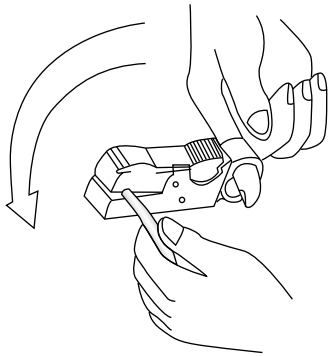

Step 1

Strip the cable.
Cut and remove the outer braid and foil. Leave only the first layer of braid (if needed, adjust cable stripper accordingly). Clean the cable inner and outer conductor with a conductor cleaner or any other appropriate equipment. For your safety and best results Corning Cabelcon's pre-adjusted Cable Stripper is recommended. Please find further information concerning these tools within our tools catalogue.
Don't forget - read the enclosed user instruction before using the tool.

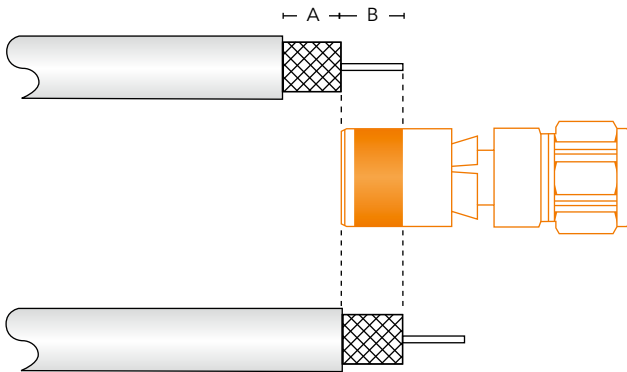

Step 2

Verify stripped dimensions by using the cutting guide on the connector.
A = 6,5 mm (outer conductor)
B = 6,5 - 8,0 mm (inner conductor)

Step 3

DO NOT FOLD BACK THE BRAID.

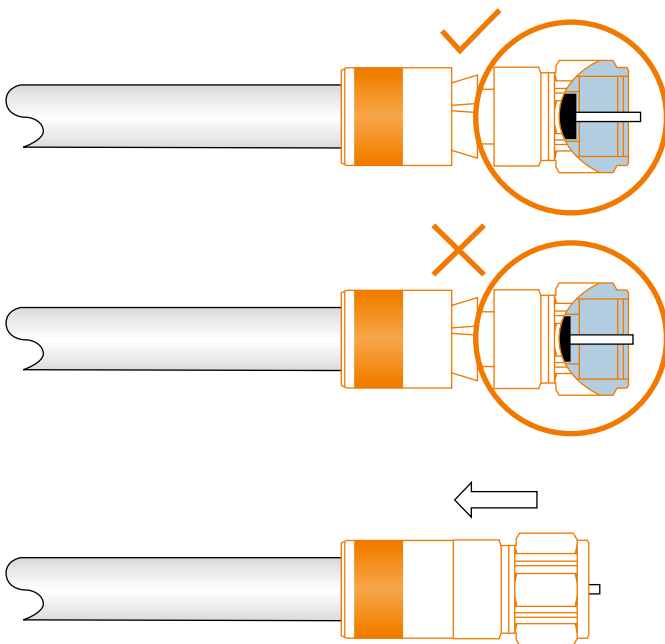

Step 4

Slide the connector gently on the cable until the PushPin™ is visible as shown left to indicate proper installation of the cable. Do not twist the connector during this operation. Make sure that the braid goes nicely into the connector. Do not bend the braid back.

Step 5

Compress the connector by using the recommended compression tool. Please find further information on compression tools in our tools catalogue.

CX3 Quick Mount™, SpringConnect and Self-install connectors

54266002
FM-RG11-CX3
QM 10,5

54269304
3,5/12m-RG11-
CX3 QM 10,5

54263903
F SC-59-CX3
3,9 Short

54264903
F SC 56-CX3
4,9 Short

54280153
F-SC-6-TD-
5,1-Short

54265122
F-56 4,9 W -
Self Install +
O-Ring

54265133
IECM-56 5,1 -
Self Install

54265134
IECF-56 5,1 -
Self Install

54265135
90-IECM-56 5,1 -
Self Install

54265136
90-IECF-56 5,1 -
Self Install



Quick Mount connectors

Item	Order No.
FM-RG11-CX3 QM 10,5 Compression F-connector QUICK-MOUNT, waterproof, suitable for a wide range of cables with an outer diameter of approx. 10,5 mm, e.g. Oren HD-163	54266002
3,5/12m-RG11-CX3 QM 10,5 Suitable for a wide range of cables with an outer diameter of approx. 10,5 mm, e.g. Oren HD-163, mounting with compression tool (Order No. 55415700), please find further information concerning compression tools within our tools catalogue	54269304

SpringConnect connectors

Item	Order No.
F-SC-59-CX3-3,9-Short Compression F-connector SpringConnect for Oren HD-083, Belden 121-T-00, F 59 TSV and RG 59-cable types, suitable as quick-connection for every F-female without screwing	54263903
F-SC-56-CX3-4,9-Short Compression F-connector SpringConnect for Oren HD-103 suitable as quick-connection for every F-female without screwing	54264903
F-SC-6-TD-5,1-Short Compression F-connector SpringConnect for Oren HD-113, suitable as quick-connection for every F-female without screwing	54280153

Self-install connectors

Item	Order No.
F-56 4,9 W - Self Install + O-Ring Compression F-connector with sealing ring for Belden H-126-T-00 and Oren HD-103, mounting without special tools	54265122
IECM-56 5,1 - Self Install IEC-connector for e.g. Oren HD-113, mounting without special tools	54265133
IECF-56 5,1 - Self Install IEC-female for e.g. Oren HD-113, mounting without special tools	54265134
90-IECM-56 5,1 - Self Install IEC-angled-connector for e.g. Oren HD-113, mounting without special tools	54265135
90-IECF-56 5,1 - Self Install IEC-angled-female for e.g. Oren HD-113, mounting without special tools	54265136

Crimp connectors

54246100
F-59-ALM 3,7/6,4



54248500
F-56-ALM 5,1/8,4



54253000
F-56-ALM 4,9/8,4



54249000
FM-RG11-
ALM 7,6/11,7



- All connector F-nuts are HEX 11
- Designed for very high strain relief
- Optimal fitting to the corresponding cable type
- High unalloyed brass as base material, NITIN surface



Parameter	F-59-ALM 3,7/6,4	F-56-ALM 5,1/8,4	F-56-ALM 4,9/8,4	FM-RG11-ALM 7,6/11,7
For cable type	Belden H-121-T-00, H-121-B	Belden H-125-CH and Ören HD-113	Belden H-126-T-00 and Ören HD-103	PRG 11 Cu, PRG 11 DB+ and Ören HD-163
Length [mm]	20,5	20,5	20,5	35,2
Frequency range [MHz]	5 – 2.500			
Screening factor [dB]	> 90			
Impedance [Ω]	75			
Operating temperature range [°C]	-37 ... +70			
Return loss [dB]	> 30			
Order No.	54246100	54248500	54253000	54249000

Crimp your connectors here for:

- H-121,
- H-121-B,
- MKL 0,8/3,5,
- BTC 1000/26,
- H125 CH,
- BKS 2050/30,
- BTC 1000/20 Cu,
- WKL 1,0/4,6 und
- WKL 1,0/4,8 CH.

Crimp your connectors here for:

- PRG 11 Cu,
- PRG 11 DB+ and
- KKL 1,6/7,2.

Please use only the recommended crimp tool with Order No. 55230000!

Please find further information within our tools catalogue.

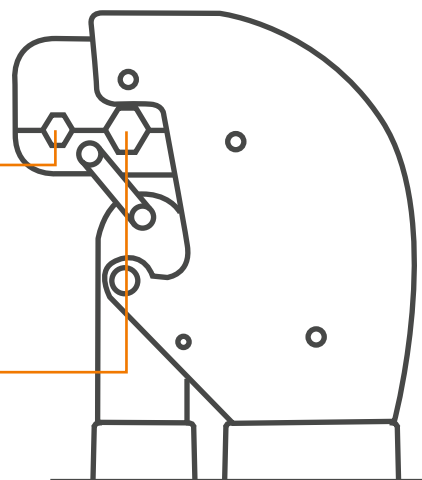

CRP 106F - .324" + .475"

Splicing instructions for compression connectors

Step 1: Strip the cable

We strongly recommend the use of our pre-adjusted Rotary Cable Stripper for RG 6, RG 59, H 121 B and H 123 B (Order No. 55294000) especially the cable stripper RG 11 (Order No. 55295000) for proper preparation of the cable. You can find further information concerning cable strippers within our tools catalogue. Please read the instructions supplied with the tool. Make sure not to damage the braid or foil during the stripping process. After completing the operation, the braid and foil must be smooth and the prepared.

Cable dimensions: A = 6,5 mm; B = 6,5 mm

Do not cut off the braid or cut into the foil or center conductor!

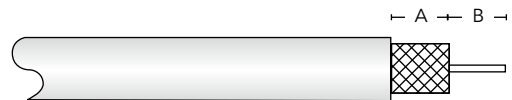
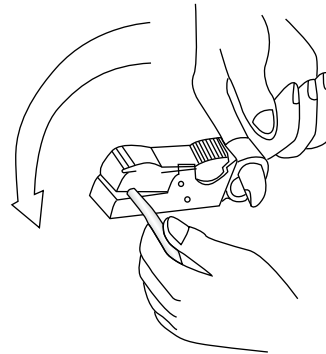

Step 2: Prepare the cable

Fold exposed braid back over the jacket. **This does not apply for FM-CX3 Mini and QuickMount connectors.** For "Quad shield", "Tri shield" and "Super shield" cables: Remove the outer braid and foil only. Fold back the inner braid. Leave the inner foil attached to the dielectric. Make sure that the foil is undamaged and smooth. If the inner conductor is too long, you may cut it down to a length of 6,5 mm. Check the length to fit the guide as shown.

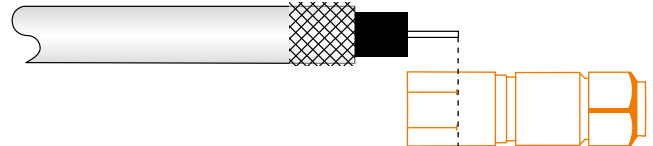

Step 3: Mount the connector

Press the front part of the connector (with the built-in "tool") against the cable and turn it slowly to prepare the foil entering the connector (not for FM-RG11-CX3, FM CX3 Mini, QuickMount and IEC-connectors).

Push the connector over the foil and allow the support mandrel to slide between the foil and the braid. A crimp handle (Order No. 55240000, only for F-connectors) and a rubber tool for cable support can be used to keep better grip on the connector and the cable during this operation. Please find further information within our tools catalogue.

Press-on the connector and turn until the dielectric is flush with the support mandrel face. At the FM-RG11-CX3 push the connector against the cable until the moveable pin is pushed forward and becomes visible as shown.

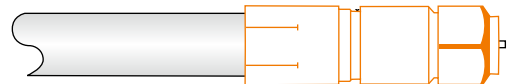

Step 4: Compress the connector

Use the compression crimp tool CAT-AS-IEC/F-FX (Order No. 55410100). Release the tool handle, insert the connector with mounted cable and close the tool handle completely as shown. Release the tool handle and remove the compressed connector. You can use the compression tool CX3 (Order No. 55415500) alternatively. Please find further information concerning compression tools within our tools catalogue.

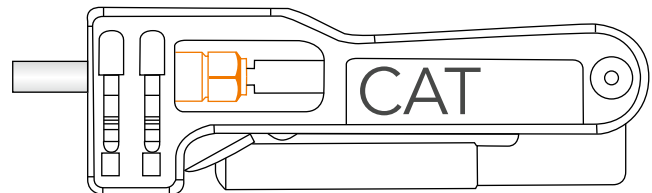

ATTENTION!

When mounting the connector into the tap, please make sure to tighten the nut with a torque of 3,4 – 5,6 Nm to avoid a decreased of performance within your network. You can find a corresponding torque wrench in our tools catalogue.

Splicing instructions for F-crimp connectors

Step 1

We strongly recommend the use of the Rotary Cable Stripper for RG 6, RG 59, H 121 B and H 123 B (Order No. 55294000) for proper preparation of the cable. You can find further information concerning cable strippers within our tools catalogue.

Stripping dimensions:

A = 6,5 mm (4 mm for EPA short).

B = 6,5 mm at IEC 169-24 (Europe) (8 mm for EPA short).

B = 8,0 mm at SCTE SP 401-199x (USA) (9,5 mm for EPA short).

However, a "B-dimension" of 6,5 mm (8,0 mm for EPA short) will be sufficient in most cases.

Do not cut off the braid or cut into the foil or center conductor!

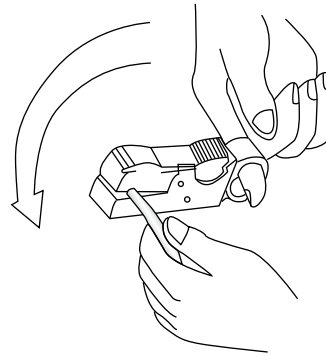

Step 2

Fold exposed braid back over jacket. For "Quad shield", "Tri shield" and "Super shield" cables: Remove the outer braid and foil only. Fold back the inner braid. Leave the inner foil attached to dielectric. Make sure that the foil is undamaged and smooth.



Step 3

Press the front part of the connector (with the built-in "tool") against the cable and turn it slowly to prepare the foil entering the connector (not EPA).

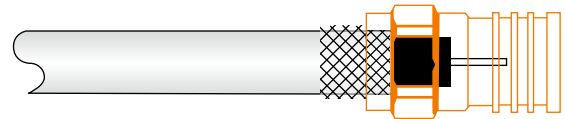

Step 4

Push the connector over the foil and allow the support mandrel to slide between the foil and braid.

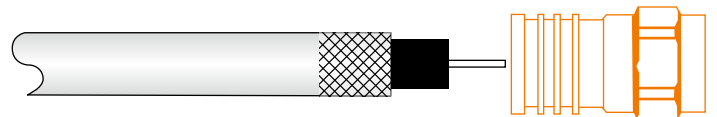

Step 5

A crimp handle can be used to keep a better grip on the connector during installation. Please find further information within our tools catalogue.

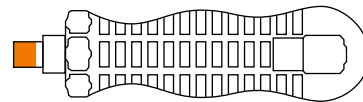

Step 6

Press and turn until the dielectric is flush with the support mandrel face.

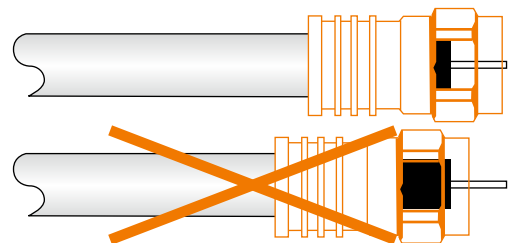

Step 7

Crimp the connector using the proper crimp tool dimension: MINI = .262", ALM = .324", UNIV = .360", EPA = .360" (for cables of type RG 11: ALM = .475", EPA = .475").

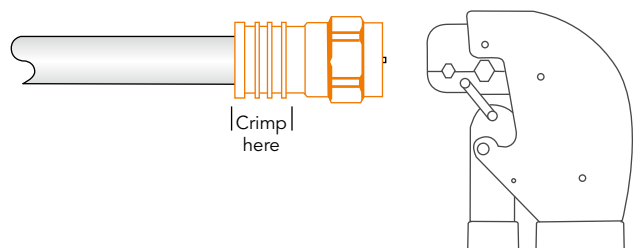

ATTENTION!

When mounting the connector into the tap, please make sure to tighten the nut with a torque of 3,4 – 5,6 Nm to avoid a decreased of performance within your network. You can find a corresponding torque wrench in our tools catalogue.

Cable fittings

For connecting coaxial cables and cables on in-ground tap-offs



Instruction how to chose the correct connector

1. Select the cable you are using from the table below.
2. Chose the fitting connector from the following page.

3. Replace the "- XX" with the braun teleCom type number.
4. Now you are able to order your desired connectors with the given name.

Übersicht der Koaxialkabel mit der entsprechenden Typ-Nummer

Parameter	Frequency [MHz]	Applies to all connectors named below
Frequency range [MHz]		5 – 3.000
Max. line power [A]		12
Screening factor [dB]		> 94
Temperature range [°C]		-37 ... +70
Through loss [dB]		< 0,1
Return loss [dB]	5 – 500	> 35,25
	500 – 1.000	> 32,50
	1.000 – 2.150	> 25,30

Coaxial cable	Inner conductor [mm]	Dielectric [mm]	Outer conductor [mm]	Outer sheath [mm]	Type No.
HD-083	0,81	3,66	–	5,80	-TL 111
H126 Txx	1,02	4,57	5,50	7,00	-TL 101
HD-103	1,02	4,60	–	6,80	-TL 101
HD-113	1,01	4,80	–	6,80	-TL 101
75 D 1,7/7,0 ikx	1,63	6,9	7,5	10,5	-TL 202
FB 11, COAX 6	1,61	7,55	8,2	11,1	-TL 212
HD-163	1,63	7,20	–	10,00	-TL 232
PRG 11 Cu	1,55	7,25	7,90	10,20	-TL 232
PRG 11 DB+	1,55	7,25	8,10	10,20	-TL 232
A-2YK2Y 1 ikx	1,10	7,30	7,80	11,00	-TL 243
KJ 1108	1,1	7,25	7,5	10,2	-TL 244
RG7 CU	1,25	5,7	6,3	8,1	-TL 245
A-2Y0K2Y 1 nkx	2,20	8,80	9,30	12,50	-TL 303
LCM 15	1,75	11,2	11,8	14,5	-TL 404
HD-223	2,20	10,20	–	13,80	-TL 413
COAX 4 FFB 14	2,20	10,20	11,00	13,80	-TL 413
COAX 3 FFB 20	3,40	14,90	15,80	19,80	-TL 646
A-2Y0K2Y 1 qkx	3,30	13,40	14,00	17,00	-TL 525
A-2Y0K2Y 1 skx	4,90	19,30	20,00	24,50	-TL 717

Grounding rings

Item	For the connectors ...	Order No.
Grounding ring type 2	-TL202, -TL205, -TL212, -TL 232, -TL240, -TL 243, -TL244, -TL245, -TL246, -TL202FI, -TL220STI, -TL250TI, -02, -12, -22, -32, -42, -203, -206, -210, -230, -240, -243, -244, -245, -246, -C202, -C212, -C220, -C232, -C243, -C250, -C263	60300200
Grounding ring type 3	-TL303, -TL306FI, -TL309, -TL310STI, -TL313, -TL319TI, -TL326, -TL343TI, -TL363, -TL383STI, -13, -63, -83, -303, -304, -309, -310, -319, -C303, -C314, -C319	60300300
Grounding ring type 4	-TL404, -TL406, -TL412, -TL413, -TL417STI, -TL418, -TL419TI, -TL424, -TL427, -TL414, -TL434TI, -TL414TI, -TL441TI, -TL444, -TL470TI, -TL494STI, -04, -14, -24, -34, -43, -44, -54, -64, -83, -84, -94, -341, -402, -405, -412, -413, -418, -419, -427, -C419, -C470	60300400
Grounding ring type 5	-TL501, -TL502, -TL505, -TL505TI, -TL506TI, -TL515, -TL517STI, -TL525, -TL530TI, -TL540TI, -05, -15, -25, -75, -502, 526, -530, -C525, -C540, -C553	60300500
Grounding ring type 6	-TL606, TL-609TI, -TL610TI, -TL611STI, -TL616, -TL619TI, -TL626, -TL636, -TL646, -TL655, -TL666TI, -TL676, -TL696STI, -06, -16, -36, -46, -55, -56, -66, -76, -96, -609, -610, -611, -C610, -C611, -C619	60300600



60152995
3,5/12f-C418

3,5/12f-C418 for connecting cable on in-ground tap-offs

Specially designed 3,5/12f connector for supplementary mounting to in-ground tap-offs with KES contact bush. Return loss > 44 dB at 1 GHz, impedance 75 Ω, waterproof, corrosion-resistant, max. tensile strength of 1.000 N.

Order No. 60152995

Mounting Instructions

Cut off the KES-contact bush, strip the cable with a special dual-strip tool, screw on the backnut to the corrugated copper tube, insert the inner conductor of the cable into the connector body and screw the backnut together with the body.

Connector types for cable fittings

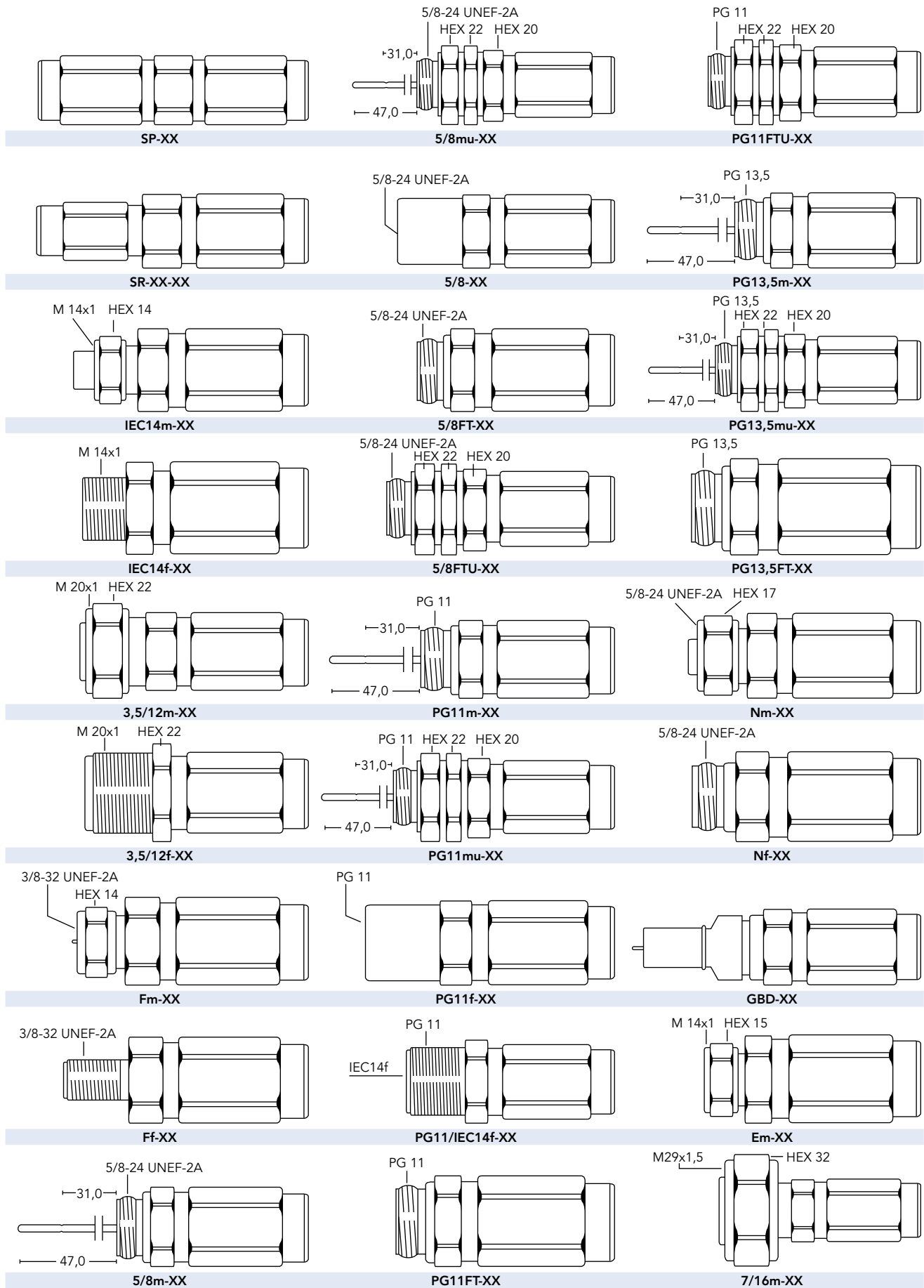

Subject to technical changes!

Splicing instructions for cable fittings, here: type-46, COAX 3FFB20

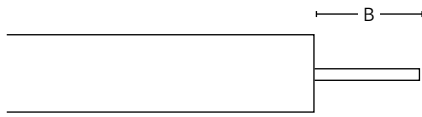

Remove the sheath, the outer conductor and the dielectric in length of:

B = 16 mm

For splicereducers (SR) please see the corresponding instructions.

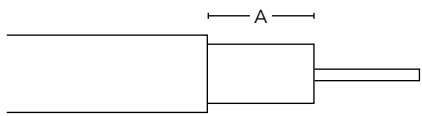

Remove the sheath in length of:

A = 14 mm

For splicereducers (SR) please see the corresponding instructions.

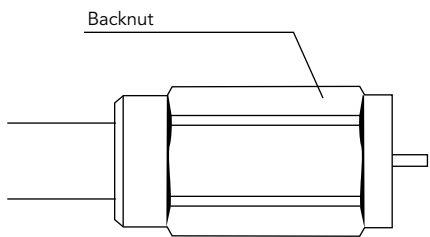

Backnut

Pull the backnut over the cable as far as possible.

For couplings (SP) and cable transitions (SR), the opposite set side mounted in a similar manner.

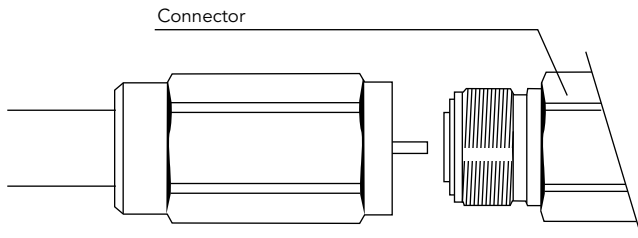

Connector

Pull the connector body over the cable's inner conductor and screw the nut tightly onto the connector body.

For couplings (SP) and cable transitions (SR), the opposite set side mounted in a similar manner.

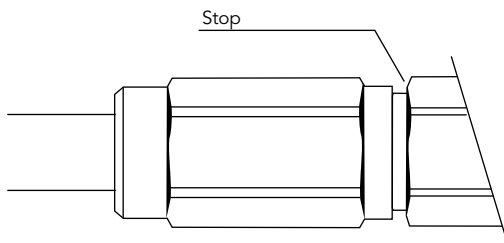

Stop

Please use two open-end wrenches. The nut is turned onto the connector body until it stops (metal against metal). Always hold the connector body while screwing the nut! Please find further information concerning wrenches within our tools catalogue

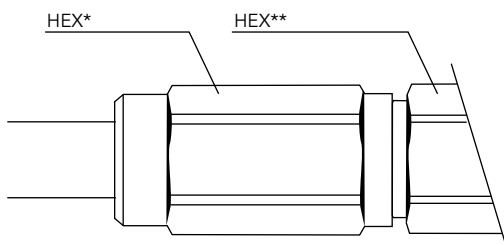

HEX*

HEX**

HEX* = 27 mm , HEX** = 27 mm

For cable transitions (SR), the largest nut must be tightened first.

Please note:
The connectors are waterproof, but must be shielded by a shrinksleeve when buried!

Jumper cables



60400721 FM-CXJ6A+- FM/TD/B/0,2	60400731 FM-CXJ6A+- FM/TD/B/0,3	60400737 FM-CXJ6A+- FM/TD/B/0,35	60400741 FM-CXJ6A+- FM/TD/B/0,4	60400751 FM-CXJ6A+- FM/TD/B/0,5	60400761 FM-CXJ6A+- FM/TD/B/0,6	60400781 FM-CXJ6A+- FM/TD/B/0,8	60400795 FM-CXJ6A+- FM/TD/B/1,0
--	--	---	--	--	--	--	--

Parameter	FM-CXJ6A+-FM/ TD/B/0,3 KDG	FM-CXJ6A+-FM/ TD/B/0,4 KDG	FM-CXJ6A+-FM/ TD/B/0,5 KDG	FM-CXJ6A+-FM/ TD/B/0,6 KDG	FM-CXJ6A+-FM/ TD/B/0,8 KDG
Description	Mini jumper F-Male to F-Male				
Length [m]	0,3	0,4	0,5	0,6	0,8
Screening [dB]	> 95	> 95	> 95	> 95	> 95
Return loss [dB]	> 34	> 32	> 35	> 34	> 34
Waterproof	Yes				
Compliant with EN 60966-2-6 Class A	Yes, A+				
Connector type	TrueDrop				
Approved by Vodafone Kabel Deutschland	Yes				
Imprint „KDG 1 TS 151“	Yes				
Order No.	60400732	60400742	60400752	60400762	60400782



Parameter	FM-CXJ6A+- FM/TD/B/0,2	FM-CXJ6A+- FM/TD/B/0,3	FM-CXJ6A+- FM/TD/B/0,35	FM-CXJ6A+- FM/TD/B/0,4	FM-CXJ6A+- FM/TD/B/0,5	FM-CXJ6A+- FM/TD/B/0,6	FM-CXJ6A+- FM/TD/B/0,8	FM-CXJ6A+- FM/TD/B/1,0
Description	Mini jumper F-Male to F-Male							
Length [m]	0,2	0,3	0,35	0,4	0,5	0,6	0,8	1,0
Screening [dB]	> 95	> 95	> 95	> 95	> 95	> 95	> 95	> 95
Return loss [dB]	> 34	> 34	> 34	> 34	> 34	> 34	> 34	> 34
Waterproof	Yes							
Compliant with EN 60966-2-6 Class A	Yes, A+							
Connector type	TrueDrop							
Order No.	60400721	60400731	60400737	60400741	60400751	60400761	60400781	60400795



We do not have the perfect jumper cable in our product portfolio yet?

We are happy to produce jumper cables according to your requirements, even in small quantities!

Adapters and terminators

	Artikel	Beschreibung	Bestell-Nr.
	PG 11M - IEC 14f	Adapter PG 11-male to IEC-female with M 14 thread	60280100
	PG 11M - 3,5/12f	Adapter PG 11-male to 3,5/12-female	60280301
	Fm - 3,5/12f	Adapter F-male to 3,5/12-female	60280406
	PG 11M - Ff	Adapter PG 11-male to F-female	60280600
	90 - Fm - Ff HQ	Angled adapter F-male to F-female	60280811
	IEC 14f - IEC 14f	Adapter IEC-female to IEC-female	60280900
	IEC 14f - Ff	Adapter IEC-female to F-female	60280905
	IEC 14f - CHASSIS Ff	Adapter IEC-female to F-female as chassis connector	60280910
	3,5/12M - IEC 14f	Adapter 3,5/12-male to IEC-female with M 14 thread	60281005
	3,5/12M - Ff	Adapter 3,5/12-male to F-female	60281010
	3,5/12M - 3,5/12M	Adapter 3,5/12-male to 3,5/12-male	60281011
	3,5/12f - 3,5/12f CHASSIS	Adapter 3,5/12-female to 3,5/12-female as chassis connector with PG 11 thread	60281000
	3,5/12f CHASSIS - Ff	Adapter 3,5/12-female to 3,5/12-female as chassis connector with PG 11 thread	60281020
	BNCf 75 Ohm - Fm	Adapter BNC-female to F-female 75 Ohm	60281710
	BNCf 75 Ohm - IECf	Adapter BNC-female to IEC-female	60281750
	5/8M - IEC 14f	Adapter 5/8-male to IEC-female with M 14 thread	60280210
	5/8M - Ff	Adapter 5/8-male to F-female	60280500
	5/8M - 3,5/12f	Adapter 5/8-male to 3,5/12-female	60280550
	5/8 - PG 11	Adapter ring 5/8-male to 3,5/12-female	60280565
	PG 11M-R 75 AC Blocking	PG 11-male as 75 Ω terminator with AC blocking	60260100
	IEC 14M-R 75 AC Blocking	IEC-male with M 14 cap nut as 75 Ω terminator with AC blocking	60260200
	3,5/12M-R 75 AC Blocking	3,5/12-male as 75 Ω terminator with AC blocking	60260300
	5/8m-R 75 AC Blocking	5/8-male as 75 Ω terminator with AC blocking	60260500

KLASSE
A
CLASS

KLASSE
A
CLASS

KLASSE
A
CLASS

KLASSE
A
CLASS

	Artikel	Beschreibung	Bestell-Nr.
	PG 11M - AC	PG 11-male as power feed-in for remote power	60290401
	5/8M - AC	5/8-male as power feed-in for remote power	60290501
	3,5/12M - AC	3,5/12-male as power feed-in for remote power	60290601
	Double splice FM-FM	Double splice – F-male to F-male adapter, 27 mm length, nickel plated brass	54210000
	F-plug-in adapter Ff-Fm/P	F-plug-in adapter for measures, fits on every F-female without screwing	54220000
	F-Schnellstecker Ff-Fm/P HQ	F-plug-in adapter HQ for measures, fits on every F-female without screwing	54220100
	F-Adapter FM-IECMP	F-adapter – F-male to IEC-male	56020000
	F-Adapter FF-IECMP	F-adapter – F-female to IEC-male	56030000
	F-Adapter FF-IECMP HQ	F-adapter HQ – F-female to IEC-male	56030500
	F-Adapter FM-IECFP	F-adapter – F-male to IEC-female	56070000
	F-Adapter FF-IECFP	F-adapter – F-female to IEC-female	56080000
	F-Adapter FF-BNCM	F-adapter – F-female to BNC-male	56040000
	F-Adapter FF-BNCM HQ	F-adapter HQ – F-female to BNC-male	56040001
	TR-59-1/4-HQ	F-terminal resistor 75 Ω – nickel plated brass	54420000
	CC-LT-R-75-ST with F-thread, long	Tamper-proof terminal resistor – 75 Ω F-terminator for unused outputs, to avoid signal-theft or interference ingress, only to open with LTT-75 (please find further information within our tools catalogue), with F-thread (26 mm)	54431000
	CC-LT-R-75-S without F-thread, short	Tamper-proof terminal resistor – 75 Ω F-terminator for not used outputs, to avoid signal-theft or interference ingress, only to open with LTT-75 (please find further information within our tools catalogue), without F-thread (20 mm)	54432000
	CC-Security Shield	In order to secure F-connections against manipulation and unauthorized disassembly, diameter 20 mm, only mountable/removable with specialty tool (Order No. 55445000), please find further information within our tools catalogue	54440000
	180-FF-FF-HQ/180-FF-FF-HQ	F-female to F-female adapter with NITIN surface in U-style, gold-plated pins, through loss < 0,2 dB, return loss > 30 dB, screening > 100 dB, transfer impedance < 0,3 mΩ/connector	54510000
	F-81-HQ-1 F-splice prof.	F-female to F-female adapter, nickel plated brass, 26 mm length, screening > 96 dB, return loss > 30 dB	54500000
	F-NUT + WAL	F-nut and wal for F-81-HQ	54391000
	Double splice female	F-female to F-female adapter with high return loss	54200000
	F-angle adapter	F-male to F-female adapter with soldered inner pin, nickel plated brass	54190000

Subject to technical changes!

CATV accessories

Attenuators



53051012
ATS-12-3G



53051110
AT-10-1G



Fixed-value attenuators in F-technique, 1,3 GHz

- Frequency range: 5 – 1.300 MHz
- F-female/F-male connectors according to IEC/EN 61169-24
- Housing with fixed HEX 11 nut at the F-male connector
- Very high screening factor according to EN 50083-2 Class A +10 dB
- Dimensions: Ø 11 mm, length 30 mm
- All fixed-value attenuators with 50 V DC blocking
- Net weight: 9 g
- Operating temperature range: -20°C – +65°C

Parameter	Frequency [MHz]	AT-2-1G	AT-3-1G	AT-4-1G	AT-6-1G	AT-8-1G	AT-10-1G
Frequency range [MHz]		5 – 1.300					
Impedance [Ω]		75					
Insertion loss [dB]	5 – 1.006	2 (± 0,3)	3 (± 0,3)	4 (± 0,3)	6 (± 0,3)	8 (± 0,3)	10 (± 0,3)
	1.006 – 1.300	2 (± 0,5)	3 (± 0,5)	4 (± 0,5)	6 (± 0,5)	8 (± 0,5)	10 (± 0,5)
Return loss [dB]	5 – 470	> 20					
	470 – 1.006	> 16					
	1.006 – 1.300	> 14					
Order No.		53051102	53051103	53051104	53051106	53051108	53051110

Parameter	Frequency [MHz]	AT-12-1G	AT-14-1G	AT-16-1G	AT-18-1G	AT-20-1G
Frequency range [MHz]		5 – 1.300				
Impedance [Ω]		75				
Insertion loss [dB]	5 – 1.006	12 (± 0,3)	14 (± 0,3)	16 (± 0,3)	18 (± 0,3)	20 (± 0,3)
	1.006 – 1.300	12 (± 0,5)	14 (± 0,5)	16 (± 0,5)	18 (± 0,5)	20 (± 0,5)
Return loss [dB]	5 – 470	> 20				
	470 – 1.006	> 16				
	1.006 – 1.300	> 14				
Order No.		53051112	53051114	53051116	53051118	53051120

Fixed-value attenuators in F-technique, 5 – 3.000 MHz

- Frequency range 5 – 3.000 MHz
- F-female/F-male connectors according to IEC/EN 61169-24
- Housing with 2 Hex 11 nuts: 1 rotatable nut at F-male and 1 lock nut at housing body
- Very high screening factor according EN 50083-2 Class A +10 dB
- Dimensions: Ø 11 mm, length 31 mm
- All fixed-value attenuators with 50 V DC blocking
- Net weight: 11 g
- Operating temperature range: -20°C – +65°C

Parameter	Frequency [MHz]	ATS-2-3G	ATS-3-3G	ATS-4-3G	ATS-6-3G	ATS-8-3G	ATS-9-3G	ATS-10-3G	ATS-12-3G	ATS-15-3G	ATS-18-3G
Frequency range [MHz]		5 – 3.000									
Impedance [Ω]		75									
Attenuation [dB]	5 – 1.006	2 (± 0,3)	3 (± 0,3)	4 (± 0,3)	6 (± 0,3)	8 (± 0,3)	9 (± 0,3)	10 (± 0,3)	12 (± 0,3)	15 (± 0,3)	18 (± 0,3)
	1.006 – 1.800	2 (± 0,5)	3 (± 0,5)	4 (± 0,5)	6 (± 0,5)	8 (± 0,5)	9 (± 0,5)	10 (± 0,5)	12 (± 0,5)	15 (± 0,5)	18 (± 0,5)
	1.800 – 2.400	2 (± 0,6)	3 (± 0,6)	4 (± 0,6)	6 (± 0,6)	8 (± 0,6)	9 (± 0,6)	10 (± 0,6)	12 (± 0,6)	15 (± 0,6)	18 (± 0,6)
Return loss [dB]	2.400 – 3.000	2,5 (± 0,9)	3,5 (± 0,9)	4,5 (± 0,9)	6,5 (± 0,9)	8,5 (± 0,9)	9,5 (± 0,9)	10,5 (± 0,9)	12,5 (± 0,9)	15,5 (± 0,9)	18,5 (± 0,9)
	5 – 470	> 20									
	470 – 1.000	> 20									
	1.000 – 1.800	> 18									
Order No.	1.800 – 2.400	> 15									
	2.400 – 3.000	> 12									
		53051002	53051003	53051004	53051006	53051008	53051009	53051010	53051012	53051015	53051018

Return path attenuators 5 – 65 MHz



5300900
RW-AT-9-65



53101501
RW-AT-15-65-2

5 – 65 MHz return path attenuators in F-technique, 1.000 MHz

- Designed for a symmetrical adjustment of the reverse path loss of each subscriber connection within a house distribution network
- Fixed values of attenuation in the reverse band 5 – 65 MHz, very low through loss inside the forward band 85 – 1.000 MHz
- F-male and F-female connectors for direct mounting onto the passive distribution equipment, diameter 13 mm, length 41 mm
- Very high screening factor according to EN 50083-2 Class A

Parameter		Frequency [MHz]	RW-AT-3-65	RW-AT-6-65	RW-AT-9-65	RW-AT-12-65
Through loss [dB]	Reverse path	5 – 65	3,0 ± 0,5	6,0 ± 0,5	9,0 ± 0,5	12,0 ± 0,5
	Forward path	85 – 100 100 – 1.000	1,5 ± 0,5 0,5 ± 0,7	1,7 ± 0,7 0,5 ± 0,7	2,6 ± 0,7 0,5 ± 0,7	2,7 ± 0,7 0,5 ± 0,7
Return loss [dB typ.]	Reverse path	5 – 55	18	18	18	18
		55 – 65	16	16	16	16
	Forward path	85 – 100 100 – 1.000	16 18	16 18	16 18	16 18
Order No.			53100300	53100600	53100900	53101200



5 – 65 MHz return path attenuators in F-technique, 1.800 MHz

- F-male and F-female connectors for direct mounting onto the passive distribution equipment
- Designed for a symmetrical adjustment of the reverse path loss of each subscriber connection within a house distribution network
- Fixed values of attenuation in the reverse band 5 – 65 MHz, very low through loss inside the forward band 85 – 1.800 MHz
- Very high screening factor according to EN 50083-2 Class A +10 dB
- Housing: Copper tube with nickel plating
- 3/8"-32UNEF connector screw threads
- Dimensions: Ø 13 mm, length 41 mm
- Net weight 15,5 g
- Operating temperature range: -20°C – +65°C

Parameter	Frequency [MHz]	RW-AT-3-65-2	RW-AT-6-65-2	RW-AT-9-65-2	RW-AT-12-65-2	RW-AT-15-65-2
Frequency range [MHz]		5 – 1.800				
Impedance [Ω]		75				
Insertion loss [dB]	5 – 65	2,0 min. 3,0 typ. 4,0 max.	5,0 min. 6,0 typ. 7,0 max.	8,0 min. 9,0 typ. 10,0 max.	11,0 min. 12,0 typ. 13,0 max.	14,0 min. 15,0 typ. 16,0 max.
		85 – 100	1,5 typ. 2,0 max.	2,0 typ. 2,5 max.	2,6 typ. 3,0 max.	2,8 typ. 3,2 max.
	101 – 1.800	0,5 typ. 1,5 max.	0,5 typ. 1,5 max.	0,5 typ. 1,5 max.	0,5 typ. 1,5 max.	0,5 typ. 1,5 max.
Return loss [dB]	5 – 55	14 min. 18 typ.	14 min. 18 typ.	14 min. 18 typ.	14 min. 18 typ.	14 min. 18 typ.
	56 – 65	10 min. 14 typ.	10 min. 14 typ.	10 min. 14 typ.	10 min. 14 typ.	10 min. 14 typ.
		85 – 100	10 min. 12 typ.	10 min. 12 typ.	10 min. 12 typ.	10 min. 12 typ.
	101 – 1.218		12 min. 14 typ.	12 min. 14 typ.	12 min. 14 typ.	12 min. 14 typ.
	1.219 – 1.800	10 min. 12 typ.	10 min. 12 typ.	10 min. 12 typ.	10 min. 12 typ.	10 min. 12 typ.
		Order No.	53100301	53100601	53100901	53101201



Return path attenuators 5 – 204 MHz & 5 – 85 MHz



53101204
RW-AT-12-204-2



53100905
RW-AT-9-85



- F-male and F-female connectors for direct mounting onto the passive distribution equipment
- Designed for a symmetrical adjustment of the reverse path loss of each subscriber connection within a house distribution network
- Very high screening factor according EN 50083-2 Class A +10 dB
- Fixed values of attenuation in the reverse band: 5 – 204 MHz for RW-AT-X-204-2 and 5 – 85 MHz for RW-AT-X-85
- Very low through loss inside the forward band: 258 – 1.800 MHz for RW-AT-X-204-2 and 85 – 1.800 MHz for RW-AT-X-85
- Housing: Copper tube with nickel plating
- 3/8" -32UNEF connector screw threads
- Dimensions: Ø 13 mm, length 41 mm
- Net weight 15,5 g
- Operating temperature range: -20°C – +65°C

Parameter	Frequency [MHz]	RW-AT-3-204-2	RW-AT-6-204-2	RW-AT-9-204-2	RW-AT-12-204-2	RW-AT-15-204-2
Frequency range [MHz]		5 – 1.800				
Impedance [Ω]		75				
Insertion loss [dB]	5 – 204	2,0 min. 3,0 typ. 4,0 max.	5,0 min. 6,0 typ. 7,0 max.	8,0 min. 9,0 typ. 10,0 max.	11,0 min. 12,0 typ. 13,0 max.	14,0 min. 15,0 typ. 16,0 max.
	258 – 330	1,5 typ. 2,0 max.	1,7 typ. 2,4 max.	2,4 typ. 3,0 max.	2,8 typ. 3,2 max.	3,0 typ. 3,5 max.
	331 – 1.800	0,5 typ. 1,2 max.	0,5 typ. 1,5 max.	0,5 typ. 1,5 max.	0,5 typ. 1,5 max.	0,5 typ. 1,5 max.
Return loss [dB]	5 – 174	14 min. 18 typ.	14 min. 18 typ.	14 min. 18 typ.	14 min. 18 typ.	14 min. 18 typ.
	175 – 204	10 min. 14 typ.	10 min. 14 typ.	10 min. 14 typ.	10 min. 14 typ.	10 min. 14 typ.
	258 – 330	12 min. 16 typ.	12 min. 16 typ.	12 min. 16 typ.	10 min. 16 typ.	10 min. 16 typ.
	331 – 860	14 min. 16 typ.	14 min. 16 typ.	14 min. 16 typ.	14 min. 16 typ.	14 min. 16 typ.
	861 – 1.800	10 min. 12 typ.	10 min. 12 typ.	10 min. 12 typ.	10 min. 12 typ.	10 min. 12 typ.
Order No.		53100304	53100604	53100904	53101204	53101504

Parameter	Frequency [MHz]	RW-AT-3-85	RW-AT-6-85	RW-AT-9-85	RW-AT-12-85	RW-AT-15-85
Frequency range [MHz]		5 – 1.800				
Impedance [Ω]		75				
Insertion loss [dB]	5 – 85	2,0 min. 3,0 typ. 4,0 max.	5,0 min. 6,0 typ. 7,0 max.	8,0 min. 9,0 typ. 10,0 max.	11,0 min. 12,0 typ. 13,0 max.	14,0 min. 15,0 typ. 16,0 max.
	105 – 120	1,5 typ. 2,0 max.	2,0 typ. 2,5 max.	2,6 typ. 3,0 max.	2,8 typ. 3,2 max.	3,0 typ. 3,5 max.
	121 – 1.800	0,5 typ. 1,5 max.	0,5 typ. 1,5 max.	0,5 typ. 1,5 max.*	0,5 typ. 1,5 max.*	0,5 typ. 1,5 max.*
Return loss [dB]	5 – 75	14 min. 18 typ.	14 min. 18 typ.	14 min. 18 typ.	14 min. 18 typ.	14 min. 18 typ.
	76 – 85	10 min. 14 typ.	10 min. 14 typ.	10 min. 14 typ.	10 min. 14 typ.	10 min. 14 typ.
	105 – 120	10 min. 12 typ.	10 min. 12 typ.	10 min. 12 typ.	10 min. 12 typ.	10 min. 12 typ.
	121 – 1.218	12 min. 14 typ.	12 min. 14 typ.	12 min. 14 typ.	12 min. 14 typ.	12 min. 14 typ.
	1.219 – 1.800	10 min. 12 typ.	10 min. 12 typ.	10 min. 12 typ.	10 min. 12 typ.	10 min. 12 typ.
Order No.		53100305	53100605	53100905	53101205	53101505

* At cross band 121 – 130 MHz with additional 0,5 dB max. (RW-AT-15-85 with additional 1,0 dB max.)

Coax termination boxes



43060200
HÜP 862 MA

HÜP 862 MA coax termination box for VF-KDG

- 5 – 1.000 MHz
- Coax termination box with testpoint at output (IEC)
- Capacitor isolated output
- Protection class IP 54
- Housing sealable
- Surge absorber (ÜsAg) retrofit
- Default delivery status contains HMA1 and HMD1

Order No. 43060200

HÜP 1.218 NA coax termination box for Unitymedia

- Coax termination box with testpoint at input and output (IEC)
- With shiftable highpass (87,5 MHz)
- With shiftable equalizer 3 dB or 6 dB
- Surge absorber (ÜsAg) retrofit
- Capacitor isolated output
- Protection class IP 54
- Housing sealable

Order No. 43060601

Accessories for HÜP 862 MA

Item	Order No.
HMH1 high pass filter 85 MHz	43060203
HMH2 high pass filter 47 MHz	43060204
HMT1 low pass filter 518 MHz	43060205
HME1 equalizer module for HÜP 862MA	43060206
HMM1 meter module	43060207
Pull-through seal, orange – BP 570, L 175 mm	43060198

Fixed-value equalizer with or without linear return path



53110300
RW-EQ-862/3



53120300
EQ-862/3

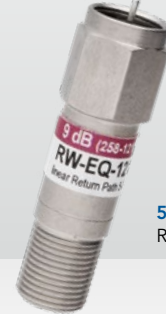

53110903
RW-EQ-1218-9

Fixed-value equalizer with linear reverse path in F-technique

- For compensation of the frequency-dependent cable slope, only in the forward way
- Frequency range 5 – 65 MHz linear and 85 – 862 MHz as equalizer
- F-male and F-female connectors
- Small, round metal housing with integrated HEX 11 nut
- Very high return loss

Parameter	Frequency [MHz]	RW-EQ-862/3	RW-EQ-862/6	RW-EQ-862/9	RW-EQ-862/12
Through loss [dB] 5 ... 50 ... 65 MHz		0 ... 0,8 ... 1,5 ± 0,5	0 ... 0,8 ... 1,5 ± 0,5	0 ... 0,8 ... 2,0 ± 0,5	0 ... 0,8 ... 2,0 ± 0,5
Slope progression [dB] 85 ... 862 MHz		3,0 ... 1,0 ± 0,5	6,0 ... 1,0 ± 0,5	9,0 ... 1,0 ± 0,5	12,0 ... 1,0 ± 0,5
Return loss [dB typ.]	5 – 65 85 – 862	> 18* > 18**	> 18* > 18**	> 18* > 18**	> 18* > 18**
Diameter [mm]		13	13	13	13
Length [mm]		46	46	46	46
Order No.		53110300	53110600	53110900	53111200

* f = 5 – 50 MHz, between 51 – 65 MHz > 16 dB typ.

** f = 101 – 862 MHz, between 85 – 100 MHz > 16 dB typ.

KLASSE
A
CLASS

Fixed-value equalizer 5 – 1.000 MHz in F-technique

Properties as stated above, but without linear reverse path frequency range (equalizer range from 5 – 862/1.000 MHz)

Parameter	EQ-862/3	EQ-862/6	EQ-862/9	EQ-862/12
Slope progression [dB] 5 ... 862 ... 1.000 MHz	3,0 ... 0,5 ... 0,3 ± 0,5	6,0 ... 0,5 ... 0,3 ± 0,5	9,0 ... 0,5 ... 0,3 ± 0,5	12,0 ... 0,5 ... 0,3 ± 0,5
Return loss [dB typ.]	> 20	> 20	> 20	> 20
Return loss [dB min.]	> 18	> 18	> 18	> 18
Diameter [mm]	13	13	13	13
Length [mm]	46	46	46	46
Order No.	53120300	53120600	53120900	53121200

KLASSE
A
CLASS

Fixed-value equalizers 258 – 1.218 MHz with linear return path 5 – 204 MHz in F-technique

- Used to compensate the frequency-dependent cable slope only in the forward path
- Frequency range 5 – 204 MHz linear and 258 – 1218 MHz with slope progression
- F female / F male connectors acc. to IEC/EN 61169-24
- NiTin coated housing with fixed HEX 11 nut at the F male connector
- Dimensions: Ø 11 mm, length 39,3 mm
- IPX8 tightness (when connected with the appropriate counterpart and correct tightening torque)
- Environmental temperature range: -40°C – +60°C
- Very high screening acc. to EN 50083-2 Class A +10 dB
- Net weight: 12 g

Parameter	Frequency [MHz]	RW-EQ-1218-3	RW-EQ-1218-6	RW-EQ-1218-9
Through loss [dB]	5 ... 184 ... 204	0 ... 0,7 ... 1,2 ± 0,3	0 ... 0,7 ... 1,2 ± 0,3	0 ... 0,7 ... 1,2 ± 0,3
Slope progressions [dB]	258 ... 1218	3,0 ... 1,0 ± 0,3	6,0 ... 1,0 ± 0,3	9,0 ... 1,0 ± 0,3
Return loss [dB]		acc. to DIN EN 60728-4 Grade 1		
Order No.		53110303	53110603	53110903

KLASSE
A
CLASS +10 dB

Fixed-value cable simulators



53130300
KS-862/3



53131204
KS-1800-12

Fixed-value cable simulators 5 – 1.000 MHz in F-technique

- For emulation of a frequency-dependent cable slope in the forward way (balancing of a preemphasis)
- Cable simulator range from 5 – 862/1.000 MHz, non-linearity at all items in the reverse path $5 - 65 \text{ MHz} \leq 0,5 \text{ dB}$
- F-male and F-female connectors
- Small, round metal housing with integrated HEX 11 nut
- Very high return loss

Parameter	KS-862/3	KS-862/6	KS-862/9	KS-862/12
Cable simulation progression [dB] 5 ... 862 ... 1.000 MHz	0 ... 3,0 ... 3,5 ± 0,5	0 ... 6,0 ... 6,5 ± 0,5	0 ... 9,0 ... 9,5 ± 0,5	0 ... 12,0 ... 12,7 ± 0,5
Return loss [dB typ.]	> 20	> 20	> 20	> 20
Return loss [dB min.]	> 18	> 18	> 18	> 18
Diameter [mm]	13	13	13	13
Length [mm]	46	46	46	46
Order No.	53130300	53130600	53130900	53131200



Fixed-value cable simulators 5 – 1.800 MHz in F-technique

- F-male and F-female connectors for direct mounting onto the passive distribution equipment
- For emulation of a frequency-dependent cable slope in the forward way (balancing of a preemphasis)
- Cable simulator range from 5 – 1.800 MHz, non-linearity at all items in the reverse path $5 - 204 \text{ MHz} \leq 0,5 \text{ dB typ.}$
- Very high screening factor according EN 50083-2 Class A +10 dB
- Housing: Copper tube with nickel plating
- 3/8"-32UNEF connector screw threads
- Dimensions: Ø 13 mm, length 41 mm, with integrated HEX 11 nut
- Net weight 16,5 g
- Operating temperature range: -20°C – +65°C

Parameter	Frequency [MHz]	KS-1800-3	KS-1800-6	KS-1800-9	KS-1800-12	KS-1800-15	KS-1800-18
Frequency range [MHz]		5 – 1.800					
Impedance [Ω]		75					
Insertion loss [dB]	5	0,2 typ. 0,8 max.	0,2 typ. 0,8 max.	0,2 typ. 0,8 max.	0,2 typ. 0,8 max.	0,2 typ. 0,8 max.	0,2 typ. 0,8 max.
	1.800	2,5 min. 3,0 typ. 3,5 max.	5,5 min. 6,0 typ. 6,5 max.	8,5 min. 9,0 typ. 9,5 max.	11,0 min. 12,0 typ. 13,0 max.	14,0 min. 15,0 typ. 16,0 max.	17,0 min. 18,0 typ. 19,0 max.
		5 – 1.218	16 min. 18 typ.	14 min. 16 typ.	14 min. 16 typ.	12 min. 16 typ.	12 min. 16 typ.
Return loss [dB]	1.219 – 1.800	14 min. 16 typ.	12 min. 14 typ.	12 min. 14 typ.	10 min. 14 typ.	10 min. 14 typ.	10 min. 14 typ.
	Order No.	53130304	53130604	53130904	53131204	53131504	53131804



UHF de-emphasis equalizers



UHF de-emphasis equalizer 551 – 1.218 MHz in F-technique

- UHF deemphasis equalizers acc. to VF TS 4003
- Used to compensate the UHF preemphasis of new 1.218 MHz C-Line amplifiers in 862 MHz mode
- Linear frequency range 5 – 550 MHz with low attenuation and 551 – 1.218 MHz with linear deemphasis progression
- F female / F male connectors acc. to IEC/EN 61169-24
- NiTin coated housing with fixed HEX 11 nut at the F male connector
- Dimensions: Ø 11 mm, length 39,3 mm
- IPX8 tightness (when connected with the appropriate counterpart and correct tightening torque)
- Environmental temperature range: -40°C – +60°C
- Very high screening acc. to EN 50083-2 Class A +10 dB
- Net weight: 13 g

Parameter	Frequency [MHz]	UHF-EQ-4003-3		UHF-EQ-4003-6		UHF-EQ-4003-9	
		Attenuation	Tolerance	Attenuation	Tolerance	Attenuation	Tolerance
Attenuation [dB]	5	0,3	± 0,3	0,2	± 0,3	0,2	± 0,3
	65	0,3	± 0,3	0,2	± 0,3	0,2	± 0,3
	100	0,3	± 0,3	0,2	± 0,3	0,2	± 0,3
	200	0,3	± 0,3	0,4	± 0,3	0,4	± 0,3
	300	0,4	± 0,3	0,4	± 0,3	0,5	± 0,3
	400	0,4	± 0,3	0,5	± 0,3	0,6	± 0,3
	500	0,5	± 0,3	0,6	± 0,3	0,7	± 0,3
	549	0,5	± 0,3	0,6	± 0,3	0,7	± 0,3
	551	0,5	± 0,4	0,6	± 0,4	0,7	± 0,4
	600	1,0	± 0,4	1,6	± 0,4	2,2	± 0,4
	700	2,0	± 0,4	3,6	± 0,4	5,2	± 0,4
	800	3,0	± 0,4	5,6	± 0,4	8,1	± 0,4
	862	3,6	± 0,5	6,8	± 0,5	10,0	± 0,5
	1.000	5,0	± 0,5	9,6	± 0,5	14,1	± 0,5
1.100	6,0	± 0,8	11,6	± 0,8	17,1	± 0,8	
1.218	7,2	± 0,8	13,9	± 0,8	20,6	± 0,8	
Return loss [dB]	12 – 30	≥ 22					
	30 – 300	≥ 20					
	300 – 470	≥ 20					
	470 – 1.006	≥ 18					
	1.006 – 1.218	≥ 14					
Order No.		53123030		53123060		53123090	

UHF de-emphasis equalizer 450 – 862 MHz in F-technique

- For compensation of the UHF pre-emphasis of C-amplifiers in 862 MHz CATV-networks
- Frequency range DC – 450 MHz almost linear and 450 – 862 MHz with de-emphasis characteristics
- F-male and F-female connectors
- Small, round metal housing with integrated HEX 11 nut
- With DC power pass 50 VDC/300 mA
- Very high return loss

Parameter	UHF-EQ-862/5	UHF-EQ-862/8	UHF-EQ-862/10	UHF-EQ-862/13	UHF-EQ-862/16	UHF-EQ-862/19
Through loss [dB] DC ... 450 MHz	0 ... 1,5 ± 0,5	0 ... 1,5 ± 0,5	0 ... 1,5 ± 0,5	0 ... 1,5 ± 0,5	0 ... 1,5 ± 0,5	0 ... 1,5 ± 0,5
Slope progression [dB] 450 ... 862 MHz	1,5 ... 5,0 ± 0,5	1,5 ... 8,0 ± 0,5	1,5 ... 10,0 ± 0,5	1,5 ... 13,0 ± 0,5	1,5 ... 16,0 ± 0,5	1,5 ... 19,0 ± 0,5
Return loss [dB typ.]	> 20*	> 20*	> 20*	> 20*	> 20*	> 20*
Diameter [mm]	13	13	13	13	13	13
Length [mm]	41	41	41	41	41	41
Order No.	53120500	53120800	53121000	53121300	53121600	53121900

* f = 40 MHz -1,5 dB/Oct. (> 14 dB min.)

Galvanic isolators

DGIS-1-SET

22380023
DGIS-1-SET, isolator



22380023
DGIS-1-SET, cover



- Protection of subscribers premise network equipment against electrical hazards caused by power surges, lightnings and variabilities in local currents
- 5 – 1.800 MHz bandwidth
- Double galvanic isolation acc. to IEC/EN 60728-11:2019-02 point 10
- Surge immunity according to IEC 61000-4-5 level 2
- Intermodulation resistance acc. to EN 60728-4 and UM TS 414
- Screening according to EN 50083-2 Class A +10 dB (30 – 1.800 MHz)
- All mounting holes with hole spacing Nx5 mm

- Housings with 12,5 mm distance between the axis of F-connector and the metal plate surface plus clearance of 7,5 mm for cable management underneath the body
- 1 GND block with screw for 6 mm² GND wire
- Compact housing design with CuSn white bronze plating, F-female connectors acc. to IEC/EN 61169-24 (Ø 9,45 ± 0,05 mm)
- DGIS-1-SET including plastic protection cover, material ABS, color RAL9010, dimensions 120 x 55 x 32 mm (H x W x D)

Parameter	Frequency [MHz]	DGIS-1-SET
Insertion loss [dB max.]	5 – 10	0,4 + 0,2
	10 – 40	0,4 + 0,2
	40 – 204	0,4 + 0,2
	204 – 258	0,4 + 0,2
	258 – 470	0,4 + 0,2
	470 – 862	0,6 + 0,2
	862 – 1.006	0,6 + 0,2
	1.006 – 1.218	0,6 + 0,3
	1.218 – 1.800	1,0 + 0,4
Return loss [dB min.]	All ports	
	5 – 15	16
	15 – 30	18
	30 – 47	18
	47 – 1.800	18*
Intermodulation distortion ⁽¹⁾ all ports (acc. to EN 60728-4 and UM TS 414) After 25 VDC surge (1,2/500µs) After 1 kV surge (1,2/50µs) After 150 VDC surge		0 dBµV / -120 dBc
		0 dBµV / -120 dBc
		0 dBµV / -120 dBc
Galvanic isolation ⁽²⁾	2120 V DC	≤ 0,7 mA during 1 minute (inner conductor input port to inner conductor output port)
	2120 V DC	≤ 0,7 mA during 1 minute (outer conductor input port to outer conductor output port)
	230 V AC	50 Hz / 60 Hz: ≤ 2,0 mA RMS (inner conductor input port to inner conductor output port)
	230 V AC	50 Hz: ≤ 2,3 mA typ. / ≤ 3,2 mA max. 60 Hz: ≤ 2,8 mA typ. / ≤ 3,8 mA max. (outer conductor input port to outer conductor output port)
Operation temperature [°C]		-25 ... +60
Order No.		22380023

* From 94 MHz with -1,5 dB/oct., but min. 12 dB

⁽¹⁾ Test setup: 2 combined test signals applied at one output port @ 120 dBµV

Test 1: with 2 signals f1 @55,25 MHz + f2 @61,25 MHz - IM harmonics measured at 2xf1 + f1+f2 + 2xf2

Test 2: with 2 signals f1 @193,25 MHz + f2 @199,25 MHz - IM harmonics measured at 2xf1 + f1+f2 + 2xf2

⁽²⁾ According to EN 60728-11:2019-02 point 10: at 2120 VDC ≥ 1 minute, leakage current ≤ 0,7 mA; at 230 VAC 50/60 Hz, Leakage current ≤ 8,0 mA RMS (inner to inner conductor and outer to outer conductor), test environmental temperature 0°C – 25°C



Mounting position
of the DGIS-1-SET
(transparency only for illustration)

Subject to technical changes!

TRIS-1002/AEN and TZU-10-02



22380010
TRIS-1002/AEN

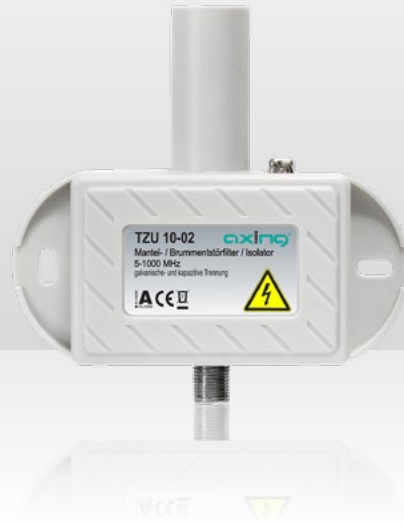

22380015
TZU-10-02



TRIS-1002/AEN

- Galvanic isolation of inner and outer conductor of home installation cables
- Prevention of equipotential bonding currents (DC) between protective grounding of the 230 V network and grounding of the CATV network (connection of these two points when connecting a PC with TV card or a cable modem via outer conductor of the CATV cable)
- Preventing the drain of leakage currents (AC) via the outer conductor of the CATV cable to the CATV grounding point in the absence of protective grounding of the 220 V socket (leakage currents are created by screen filters in power converter PSUs of PCs, with transients to ground – the PC chassis – and subsequently to be discharged via the mains voltage protective conductor to earth)
- A housing for TRIS-1002/AEN, plastic, color: ivory, is available separately with Order No. 22380011.

Parameter	Frequency [MHz]	TRIS-1002/AEN	
Through loss [dB]	IN – OUT	5 – 40	0,2 ± 0,3
		40 – 470	0,2 ± 0,3
		470 – 1.000	0,4 ± 0,3
		1.000 – 1.006	0,4 ± 0,3
Return loss [dB typ.]	IN	5 – 40	> 20
		40 – 470	> 18
		470 – 1.000	> 18
		1.000 – 1.006	> 18
	OUT	5 – 40	> 20
		40 – 470	> 18
		470 – 1.000	> 18
		1.000 – 1.006	> 18
Galvanic Isolation		According to EN 50083-1/A1§9	
Inner conductor IN to inner conductor OUT & outer conductor IN to outer conductor OUT		2.120 VDC for at least 1 minute not exceeding 0,2 mA leakage current, 230 V RMS 50/60 Hz not exceeding 2,0 mA RMS – surge protection at input	
Order No.		22380010	

TZU-10-02

The sheath current filter with isolating transformer TZU-10-02 prevents faults that can arise due to sheath currents or unfavorable grounding conditions.

Parameter	TZU-10-02
Frequency range [MHz]	5 – 1.006
Through loss [dB]	< 0,5
Return loss [dB]	> 20, -1,5 dB/OCT
Impedance [Ω]	75
Connections	F-Female
Order No.	22380015

Block filters

Block filters for star distribution of CATV networks



57225500
M-HPF-85



57011000
HPF-111



57011025
HPF-258-2-N

- Block filters to lock out some channels or channel groups in CATV star distribution networks
- F-male and F-female connectors for direct mounting onto the passive F-distribution network

- Small, round metal housing with integrated HEX 11 nut (WHPF-xx with HEX 15 nut)
- Very low crossing band width, very high rejection and low through loss
- Very high return loss, screening according EN 50083-2 Class A

Parameter	Reverse path block filters		High pass filter (FM-block filter)	Three band block filter
	WHPF-47E	M-HPF-85	HPF-111	TBF 5-108/174-230/518-1.000
Pass band [MHz]	47 – 1.000	84 – 1.000	111 – 1.000 (S 2 – K 69)	5 – 108 174 – 230 518 – 1.000
Through loss [dB]	≤ 1,0	≤ 1,5 ¹⁾ / ≤ 0,5 ²⁾	≤ 3,5 (111 – 130 MHz), ≤ 1,0 (130 – 1.000 MHz)	2,0 (5 – 108 MHz) 2,5 (174 – 230 MHz) 2,5 (518 – 1.000 MHz)
Stop band [MHz]	0 – 30	0 – 64	0 – 108 (0 – UKW)	125 – 160 248 – 1.000
Rejection [dB]	> 50	> 60	> 50 (0 – 100 MHz) > 12 (100 – 108 MHz)	> 45
Cross channels [MHz]	–	–	–	–
Return loss [dB]	> 18*	> 20*	> 16 (111 – 130 MHz), > 18 (130 – 1.000 MHz)	16 dB typ (5 – 108 MHz) 16 dB typ (174 – 230 MHz) 16 dB typ (518 – 1.000 MHz)
Diameter [mm]	ca. 17	13	21	21
Length [mm]	48,2	39,5	45/57 (with/without F-female)	77/89 (with/without F-female)
Order No.	57215000	57225500	57011000	57180108

* f = 85 MHz -1,5 dB/Oct. (> 16 dB min.) ¹⁾ 85 – 108 MHz ²⁾ 108 – 1.000 MHz

HPF-258-2-N for CATV multimedia networks

- High pass filter for blocking the return path frequency range 5 – 204 MHz in modern CATV multimedia networks
- F female / F male connectors acc. to IEC/EN 61169-24
- NiTin coated housing with fixed HEX 11 nut at the F male connector
- Very high screening acc. to EN 50083-2 Class A +10 dB

- Dimensions: Ø 11 mm, length 33 mm
- IPX8 tightness (when connected with the appropriate counterpart and correct tightening torque)
- Environmental temperature range: -40°C – +60°C
- Net weight: 11 g

Parameter	Frequency [MHz]	HPF-258-2-N	
Frequency range [MHz]		5 – 1.800	
Impedance [Ω]		75	
Pass band [MHz]		258 – 1.800	
Insertion loss [dB]	258 – 1.218	1,0 typ.	1,5 max.
	1.219 – 1.800	0,8 typ.	1,0 max.
Return loss [dB]		acc. to DIN EN 60728-4 Grade 1	
Stop band [MHz]		5 – 204	
Rejection [dB]	5 – 204	50 typ.	45 min.
Order No.		57011025	

We do not have the perfect block filter in our product portfolio yet?

We are happy to produce block filters according to your requirements, even in small quantities!

Block filters for star distribution CATV networks and return path block filter for operations in SAT-IF-distribution networks



KLASSE
A
CLASS

Block filters for star distribution CATV networks

Parameter	Ingress suppression block filters		
	HPF-12MH	HPF-15MH	HPF-25MHA
Pass band [MHz]	12 – 1.006	15 – 1.006	25 – 1.006
Through loss [dB]	≤ 1,0 ¹⁾	≤ 1,0 ²⁾	≤ 1,0 ³⁾
Stop band [MHz]	0 – 7	0 – 9	0 – 18
Rejection [dB]	> 55	> 55	> 55
Cross channels	–	–	–
Return loss [dB]	> 18*	> 18*	> 18*
Diameter [mm]	approx. 13	approx. 13	approx. 13
Length [mm]	41	41	41
Order No.	57021200	57021500	57022500

¹⁾ between 12 – 15 MHz ≤ 2,5 dB max.

²⁾ between 15 – 18 MHz ≤ 2,5 dB max.

³⁾ between 25 – 30 MHz ≤ 2,5 dB max.

* f = 85 MHz -1,5 dB/Oct. (> 16 dB min.)

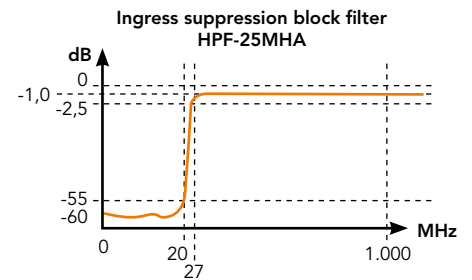

Return path block filter for operations in SAT-IF-distribution networks

- Block filter for blocking the return path frequency range in SAT-IF star-distribution networks in combination with multimedia applications
- Admission of the switching DC voltage and the 22 kHz and DiSEqC signals
- Very low crossing band width, very high rejection and low through loss
- Small rounded metal housing with integrated HEX 11 nut, F-male and F-female connectors
- High return loss, screening according EN 50083-2 Class A

Parameter	Frequency [MHz]	RSF-8-65
Pass band [MHz]		DC – 5
		80 – 2.400
Through loss [dB]	DC – 5	≤ 2,0
	80 – 87,5	≤ 2,0
	87,5 – 1.000	≤ 1,0
	1.000 – 2.150	≤ 2,0
	2.150 – 2.400	≤ 2,5
Stop band [MHz]		8 – 65
Rejection [dB]		> 50
Cross channels		–
Return loss [dB]		> 16*
DC passing max.		30 V/500 mA
Diameter [mm]		21
Length [mm]		67
Order No.		57226000

* f = DC – 5 MHz & 80 MHz -1,5 dB/Oct. (> 12 dB min.)

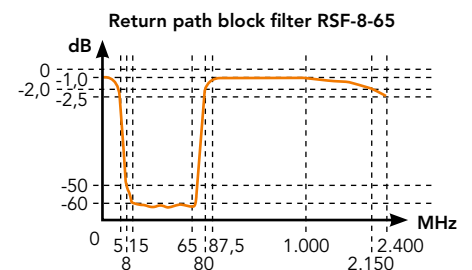

We do not have the perfect block filter in our product portfolio yet?

We are happy to produce block filters according to your requirements, even in small quantities!

LTE block filters with F-male/F-female connectors, short



57142790
LPF-790-SHORT



- Block filters for elimination of the impact of harmful interferences from LTE/MFCN base stations at DVB-T devices (Digital Dividend)
- Short, round metal housing, F-male and F-female connectors
- Very low crossing band width, very high rejection and low through loss
- High return loss, screening according to EN 50083-2 Class A

Parameter	LPF-790-SHORT	LPF-782-SHORT	LPF-774-SHORT	LPF-766-SHORT	LPF-758-SHORT
Pass band [MHz]	0,3 – 790 (0,3 – channel 60)	0,3 – 782 (0,3 – channel 59)	0,3 – 774 (0,3 – channel 58)	0,3 – 766 (0,3 – channel 57)	0,3 – 758 (0,3 – channel 56)
Through loss [dB]	≤ 1,0 (5 – 700 MHz) ≤ 3,0 (700 – 790 MHz)	≤ 1,0 (5 – 700 MHz) ≤ 3,0 (700 – 782 MHz)	≤ 1,0 (5 – 700 MHz) ≤ 3,0 (700 – 774 MHz)	≤ 1,0 (5 – 700 MHz) ≤ 3,0 (700 – 766 MHz)	≤ 1,0 (5 – 700 MHz) ≤ 3,0 (700 – 758 MHz)
Stop band [MHz]	822 – 1.000	814 – 1.000	806 – 1.000	798 – 1.000	790 – 1.000
Rejection [dB]	> 50	> 50	> 50	> 50	> 50
Cross channels [MHz]	790 – 822 (K 61 – K 64)	782 – 814 (K 60 – K 63)	774 – 806 (K 59 – K 62)	766 – 798 (K 58 – K 61)	758 – 790 (K 57 – K 60)
Return loss [dB]	> 16 (f = 5 – 790 MHz)	> 16 (f = 5 – 782 MHz)	> 16 (f = 5 – 774 MHz)	> 16 (f = 5 – 766 MHz)	> 16 (f = 5 – 758 MHz)
DC passing max.	30 V/500 mA	30 V/500 mA	30 V/500 mA	30 V/500 mA	30 V/500 mA
Diameter [mm]	21	21	21	21	21
Length [mm]	57	57	57	57	57
Order No.	57142790	57142782	57142774	57142766	57142758

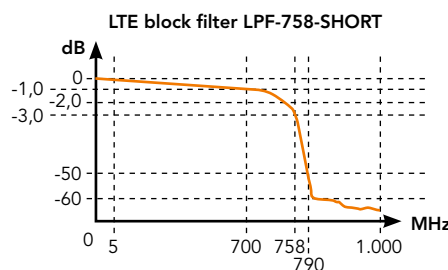
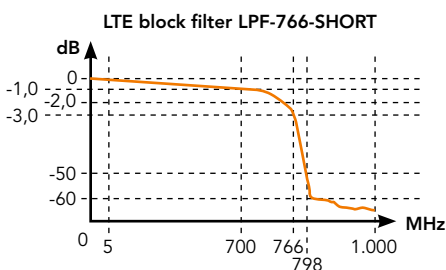
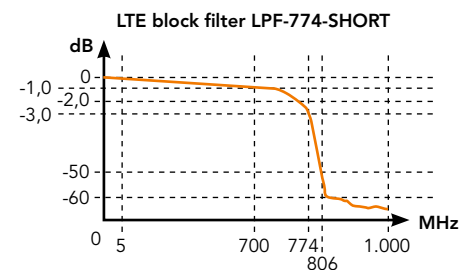
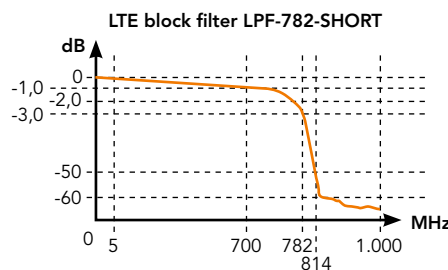
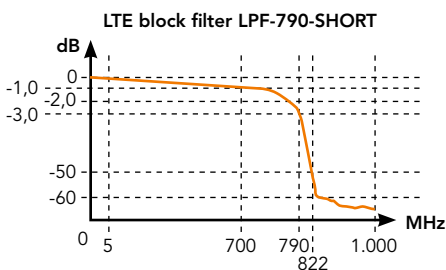

We do not have the perfect block filter in our product portfolio yet?

We are happy to produce block filters according to your requirements, even in small quantities!

Subject to technical changes!

DPX-1 diplex filters in F-technique & 90° angled block filters



57005700
DPX-1-65/85



DPX-1 diplex filters in F-technique

- Diplex filters for combining or splitting of different frequency bands in CATV and SMATV broadband networks
- Compact die-cast housing with grounding connections
- F-female connectors, all connectors are facing in the same direction
- Very low crossing band width, very high rejection and isolation, very high return loss

Parameter		DPX-1-65/85	DPX-1-85/108-1800	DPX-1-204/258-1800	DPX-1-862/950
Frequency range [MHz]	Port 1	5 – 65	5 – 85	5 – 204	5 – 862
	Port 2	85 – 1.006	108 – 1.800	258 – 1.800	950 – 2.400
Tap loss [dB]	Port 1	0,7 ± 0,8 > 55 typ.	1,0 typ. 1,5 max.	1,0 typ. 1,5 max.	1,5 ± 0,8 > 45 typ.
	Port 2	0,5 ± 0,8 > 55 typ.	1,0 typ. 1,5 max.	1,0 typ. 1,5 max.	1,5 ± 0,8 > 42 typ.
Isolation [dB]		≥ 60 (5 – 1.000 MHz)	≥ 45 (5 – 1.800 MHz)	≥ 45 (5 – 1.800 MHz)	≥ 42 (5 – 2.400 MHz)
Return loss [dB]	Port 1	> 20 (5 – 60 MHz) > 18 (60 – 65 MHz)	16 min. 18 typ.	16 min. 18 typ.	> 20 (5 – 65 MHz) > 16 (65 – 862 MHz)
	Port 2	> 16 (85 – 90 MHz) > 20 (90 – 1.000 MHz)	> 16 (108 – 1.300 MHz) > 12 (1.300 – 1.800 MHz)	> 16 (258 – 1.300 MHz) > 12 (1.300 – 1.800 MHz)	> 14 (950 – 2.400 MHz)
DC passing max.	Port 1	–	–	–	–
	Port 2	–	–	–	24 VDC/1 A (incl. DiSEqC and 22 kHz)
Dimensions [mm]		74,5 x 33 x 18	74,5 x 33 x 18	74,5 x 33 x 18	74,5 x 33 x 18
Order No.		57005700	57005710	57005715	57006500

90° angled block filter, 258 – 1.218 MHz

Parameter	Frequency [MHz]	90-HPF-258-IEC	
Frequency range		5 – 1.218	
Impedance [Ω]		75	
Pass band [MHz]		258 – 1.218	
Insertion loss [dB]	258 – 1.218	1,5 typ.	2,0 max.
	258 – 862	14 min.	16 typ.
Return loss [dB]	863 – 1.218	12 min.	14 typ.
Stop band [MHz]		5 – 204	
Rejection [dB]	5 – 198	40 min.	50 typ.
	199 – 204	40 min.	45 typ.
Connectors		IEC male & IEC female	
Order No.		57011026	

ANTENNA WALL OUTLETS

Do you have questions concerning our products or want to place an order?

We look forward to your call!
+49 511 757086

Do you already know, which products you need?
shop.brauntelecom.com

Broadband antenna outlets up to 2 GHz

1-port double galvanic isolated antenna outlets up to 2 GHz



24000005
btv-1IEC-NL



24100701
SAD-03



- TV-port broadband 5 – 2.000 MHz
- Intermodulation resistant according to EN 60728-4
- High screening according to Class A +10 dB
- Surface coated with CuSn white bronze plating, thereby corrosion resistant
- Available as IEC-version (double galvanic isolated IEC-male for TV) and as F-Version (double galvanic isolated F-female for TV)
- Cover plate SAD-03, color Pure white RAL 9010, with removable blind cap at the radio-port (Order No. 24100701)
- Surface-mount frame SAD-165, 80 x 80 x 33 mm, color Pure white RAL 9010, for multimedia outlets (Order No. 22080800)

Parameter	Frequency [MHz]	btv-1IEC-NL	
Tap loss [dB]	IN – PORT 1	5 – 12	0,5 ± 0,4
		12 – 470	0,5 ± 0,4
		470 – 1.006	0,5 ± 0,4
		1.006 – 1.700	0,7 ± 0,5
		1.700 – 2.000	0,9 ± 0,5
Return loss [dB]	ALL	5 – 12	≥16
		12 – 300	≥20
		300 – 800	≥18
		800 – 1.006	≥16,5
		1.006 – 1.700	≥14
		1.700 – 2.000	≥12
Intermodulation ⁽¹⁾ [dBμV min]		115	
Galvanic Isolation		≤ 8 mA, 230V AC 50/60 Hz; ≤ 0,7 mA, 2.120 VDC (1 minute)	
Surge protection		1 kV 1,2/50 μs	
Order No.		24000005	

⁽¹⁾ With test signals P = 60 MHz, Q = 65 MHz applied at DATA, TV OUT respectively, intermodulation distortion level is ≤ 15 dBμV at 2 P = 120 MHz, at P + Q = 125 MHz, at 2 Q = 130 MHz

Also available as a bundle!

The btv-1-IEC-NL-SET includes, in addition to the 1-port double galvanic isolated antenna outlet btv-1-IEC-NL, a matching surface-mount frame, a cover plate and 2,0 m Cu grounding cable!
Order No. **24000007**

Accessories

Double galvanic isolated connection box, 5 – 2.000 MHz, Input: F-male with ground connector, tap loss typ. 1 x 0,5 dB, intermodulation resistant according to DIN EN 60728-4, high screening according to Class A +10 dB, as bundle incl. ABS isolated plastic frame, Pure white RAL 9010 & 2,0 m Cu grounding wire
btv-DGIB-1-SET: Output 1x IEC-male
Order No. **24000008**



24000008
btv-DGIB-1-SET,
front and back view



1-port and 2-port broadband antenna outlets up to 2 GHz

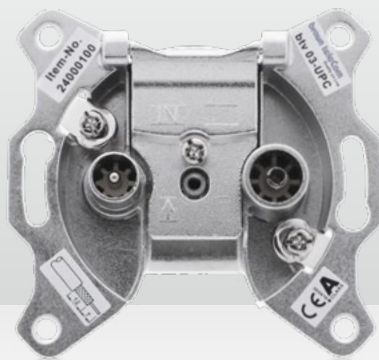

24000100
btv-03-UPC

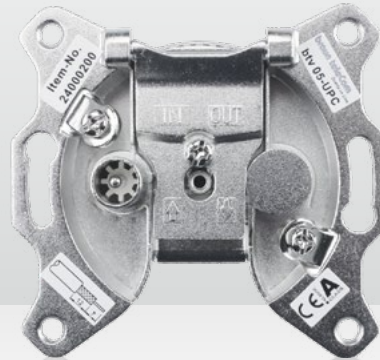

24000200
btv-05-UPC



- All outlets with broadband ports 5 – 2.000 MHz
- Intermodulation resistant according to EN 60728-4
- High screening according to Class A +10 dB
- Clamp technology for inner conductor with diameter 0,4 – 1,2 mm
- Surface coated with CuSn white bronze plating, thereby corrosion resistant
- Suitable for coax cables with diameter 4,1 – 7,2 mm

- 7 versions with 1-port and 2-port as well as with IEC- and F-connections available
- Cover plate SAD-03, color Pure white RAL 9010, with removable blind cap at the radio-port (Order No. 24100701)
- Surface-mount frame SAD-165, 80 x 80 x 33 mm, color Pure white RAL 9010, for multimedia outlets (Order No. 22080800)

Parameter	Frequency [MHz]	Terminal type			Loop-through type			
		btv-01-UPC	btv-03-UPC	btv-04-A	btv-05-UPC	btv-06-UPC	btv-07-UPC	
Through loss [dB]	IN – OUT	5 – 12	–	–	–	4,0 ± 0,3	4,0 ± 0,3	4,0 ± 0,3
		12 – 470	–	–	–	3,7 ± 0,4	3,7 ± 0,4	3,7 ± 0,4
		470 – 1.006	–	–	–	4,0 ± 0,4	4,0 ± 0,4	4,0 ± 0,4
		1.006 – 1.700	–	–	–	4,6 ± 0,5	4,6 ± 0,5	4,6 ± 0,5
		1.700 – 2.000	–	–	–	5,2 ± 0,8	5,2 ± 0,8	5,2 ± 0,8
Tap loss [dB] ⁽³⁾	IN – PORT 1	5 – 12	0,2 ± 0,2	4,0 ± 0,3	4,0 ± 0,3	4,0 ± 0,3	7,4 ± 0,8	7,4 ± 0,8
		12 – 470	0,2 ± 0,2	3,7 ± 0,4	3,7 ± 0,4	3,7 ± 0,4	7,3 ± 0,8	7,3 ± 0,8
		470 – 1.006	0,2 ± 0,2	4,0 ± 0,4	4,0 ± 0,4	4,0 ± 0,4	8,0 ± 0,8	8,0 ± 0,8
		1.006 – 1.700	0,4 ± 0,2	4,6 ± 0,5	4,6 ± 0,5	4,6 ± 0,5	9,0 ± 1,0	9,0 ± 1,0
		1.700 – 2.000	0,5 ± 0,3	5,2 ± 0,8	5,2 ± 0,8	5,2 ± 0,8	10,0 ± 1,5	10,0 ± 1,5
	IN – PORT 2	5 – 12	–	4,0 ± 0,3	4,0 ± 0,3	–	7,4 ± 0,8	7,4 ± 0,8
		12 – 470	–	3,7 ± 0,4	3,7 ± 0,4	–	7,3 ± 0,8	7,3 ± 0,8
		470 – 1.006	–	4,0 ± 0,4	4,0 ± 0,4	–	8,0 ± 0,8	8,0 ± 0,8
		1.006 – 1.700	–	4,6 ± 0,5	4,6 ± 0,5	–	9,0 ± 1,0	9,0 ± 1,0
		1.700 – 2.000	–	5,2 ± 0,8	5,2 ± 0,8	–	10,0 ± 1,5	10,0 ± 1,5
Isolation [dB] ⁽⁴⁾	PORT – PORT	5 – 12	–	25	25	–	25	25
		12 – 470	–	30	30	–	30	30
		470 – 1.006	–	25	25	–	25	25
		1.006 – 1.700	–	20	20	–	20	20
		1.700 – 2.000	–	15	15	–	15	15
	OUT – PORT	5 – 12	–	–	–	25	25	25
		12 – 470	–	–	–	30	30	30
		470 – 1.006	–	–	–	25	25	25
		1.006 – 1.700	–	–	–	20	20	20
		1.700 – 2.000	–	–	–	15	15	15
Return loss [dB]	ALL	5 – 12	≥ 16	≥ 14	≥ 14	≥ 14	≥ 14	≥ 14
		12 – 300	≥ 20	≥ 16	≥ 16	≥ 16	≥ 16	≥ 16
		300 – 1.006	≥ 18	≥ 16	≥ 16	≥ 16	≥ 16	≥ 16
		1.006 – 1.700	≥ 14	≥ 14	≥ 14	≥ 14	≥ 14	≥ 14
		1.700 – 2.000	≥ 12	≥ 12	≥ 12	≥ 12	≥ 12	≥ 12
MoCA reduces isolation ⁽¹⁾ (dB max)	1.200 – 1.625	–	20	20	22	22	22	
Intermodulation ⁽²⁾ (dBμV min)		115	115	115	115	115	115	
IEC-male TV		Yes	Yes	–	Yes	Yes	–	
IEC-female radio		–	Yes	–	–	Yes	–	
Amount F-females		–	–	2	–	–	2	
Order No.		24000000	24000100	24000152	24000200	24000250	24000260	

⁽¹⁾ With open input (accordant POE-Filter)

⁽²⁾ With test signals P = 60 MHz, Q = 65 MHz applied at DATA, TV OUT respectively, intermodulation distortion level is ≤ 15 dBuV at 2 P = 120 MHz, at P + Q = 125 MHz, at 2 Q = 130 MHz

⁽³⁾ These specifications are typical values, the IN-Port attenuation at the cross bands of each mentioned frequency band can exceed or fall below by 0,3 dB max. in mass production.

⁽⁴⁾ These specifications are typical values, the Port-Port isolation at the cross bands of each mentioned frequency band can fall below by 1 dB max. in mass production.

Accessory: btv-01-SET: btv 01-UPC incl. SAD 03 (neutral) as bundle

Order No. 24000002

2-port multimedia broadband antenna outlets

with DATA-port (5 – 1.800 MHz) and TV-port (258 – 1.800 MHz)

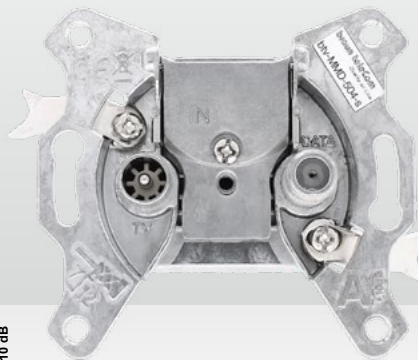

21932504
btv-MMD-504-s

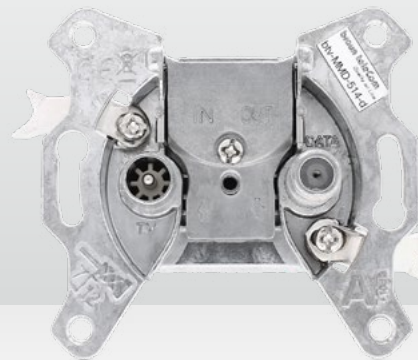

21932514
btv-MMD-514-d



- Dimensions according to DIN 45330
- Quick and comfortable installation thanks to push-pin clamp technology
- High protection against any LTE ingress (LTE safe)
- Zinc die-cast housing with polished finishing
- Clamp technology for inner conductors with a diameter of 0,4 – 1,2 mm
- Suitable for coaxial cables with a diameter of 4,1 – 7,2 mm
- Surge immunity 1 kV according to IEC 61000-4-5 level 2
- Broadband DATA-port 5 – 1.800 MHz, selective TV-port 258 – 1.800 MHz
- Ready for DOCSIS® 3.1
- Cover plate SAD-122, white RAL 9010, is not included and needs to be ordered separately (Order No. 22080122)
- High screening according to Class A +10 dB following DIN EN 50083-2

Parameter	Frequency [MHz]	btv-MMD-504-s	btv-MMD-510-T	btv-MMD-511-d	btv-MMD-514-d	btv-MMD-517-d	btv-MMD-520-d	
Insertion loss [dB]	IN – OUT	5 – 470	–	–	3 ± 0,5 max.	2 ± 0,5	1 ± 0,5	0,5 ± 0,5
		470 – 1.218	–	–	3 ± 1 max.	2 ± 1	1 ± 1	0,5 ± 1
	IN – DATA	1.218 – 1.800	–	–	3 ± 1,5 max.	2 ± 1,5	1 ± 1,5	0,5 ± 1,5
		5 – 1.218	4 ± 1	10 ± 1	11 ± 1	14 ± 1	17 ± 1	20 ± 1
	IN – TV	1.218 – 1.800	4 ± 1,5	10 ± 1,5	11 ± 1,5	14 ± 1,5	17 ± 1,5	20 ± 1,5
		5 – 65	50 min.	50 min.	50 min.	50 min.	50 min.	50 min.
65 – 204		40 min.	40 min.	40 min.	40 min.	40 min.	40 min.	
258 – 1.218		4,5 ± 1 ⁽¹⁾	10,5 ± 1 ⁽¹⁾	11,5 ± 1 ⁽¹⁾	14,5 ± 1 ⁽¹⁾	17,5 ± 1 ⁽¹⁾	20,5 ± 1 ⁽¹⁾	
Isolation [dB min.]	1.218 – 1.800	4,5 ± 1,5 ⁽²⁾	10,5 ± 1,5 ⁽²⁾	11,5 ± 1,5 ⁽²⁾	14,5 ± 1,5 ⁽²⁾	17,5 ± 1,5 ⁽²⁾	20,5 ± 1,5 ⁽²⁾	
	TV – DATA	5 – 65	70 typ. 60 min.	70 typ. 60 min.	70 typ. 60 min.	70 typ. 60 min.	70 typ. 60 min.	70 typ. 60 min.
65 – 204		60 typ. 55 min.	60 typ. 55 min.	60 typ. 55 min.	60 typ. 55 min.	60 typ. 55 min.	60 typ. 55 min.	
204 – 258		55 – 26	55 – 26	55 – 26	55 – 26	55 – 26	55 – 26	
258 – 862		30 typ. 26 min.	30 typ. 26 min.	30 typ. 26 min.	30 typ. 26 min.	30 typ. 26 min.	30 typ. 26 min.	
862 – 1.006		30 typ. 24 min.	30 typ. 24 min.	30 typ. 24 min.	30 typ. 24 min.	30 typ. 24 min.	30 typ. 24 min.	
1.006 – 1.500		25 typ. 20 min.	25 typ. 20 min.	25 typ. 20 min.	25 typ. 20 min.	25 typ. 20 min.	25 typ. 20 min.	
OUT – TV	1.500 – 1.800	20 typ. 15 min.	20 typ. 15 min.	20 typ. 15 min.	20 typ. 15 min.	20 typ. 15 min.	20 typ. 15 min.	
	5 – 65	–	–	70 typ. 60 min.	70 typ. 60 min.	70 typ. 60 min.	70 typ. 60 min.	
	65 – 204	–	–	56 typ. 50 min.	60 typ. 55 min.	60 typ. 55 min.	60 typ. 55 min.	
	204 – 258	–	–	50 – 25	55 – 28	55 – 28	55 – 28	
	258 – 862	–	–	30 typ. 25 min.	35 typ. 28 min.	35 typ. 28 min.	35 typ. 28 min.	
	862 – 1.006	–	–	30 typ. 25 min.	30 typ. 26 min.	30 typ. 26 min.	30 typ. 26 min.	
OUT – DATA	1.006 – 1.800	–	–	30 typ. 25 min.	30 typ. 25 min.	30 typ. 25 min.	30 typ. 25 min.	
	5 – 65	–	–	35 min.	35 min.	35 min.	35 min.	
	65 – 204	–	–	30 min.	30 min.	30 min.	30 min.	
	204 – 258	–	–	30 min.	30 min.	30 min.	30 min.	
	258 – 862	–	–	25 min.	28 min.	28 min.	28 min.	
	862 – 1.006	–	–	25 min.	26 min.	26 min.	26 min.	
Return loss [dB min.]	1.006 – 1.800	–	–	25 min.	25 min.	25 min.	25 min.	
	IN & OUT	5 – 47	16					
	TV	47 – 1.800	16 (at 47 MHz -1,5 dB/Oct. 10 dB min.)					
		258 – 1.800	14 (at 258 MHz -1,5 dB/Oct. 10 dB min.)					
DATA	5 – 10	14						
	10 – 47	18						
	47 – 1.800	18 (at 47 MHz -1,5 dB/Oct. 10 dB min.)						
Impedance [Ω]		75						
Operating temperature range [°C]		0 – 55						
Harmonic distortion [dBμV]	before surge	< 2						
	after 25 VDC surge	< 15						
Order No.		21932504	21932510	21932511	21932514	21932517	21932520	

⁽¹⁾ In frequency range 258 – 266 MHz with additional 0,5 dB attenuation
⁽²⁾ In frequency range 1.700 – 1.800 MHz with additional 0,5 dB attenuation

⁽³⁾ With 2 x 120 dBμV test signals combined and applied to DATA-Port:
 Test 1: f1 = 60 MHz, f2 = 65 MHz, IM2 = 2 x f1 + f1+f2 + 2 x f2
 Test 2: f1 = 199 MHz, f2 = 204 MHz, IM2 = 2 x f1 + f1+f2 + 2 x f2

Broadband push on adapters

2-port and 3-port broadband push on adapters up to 2 GHz



24100002
POA-01-A

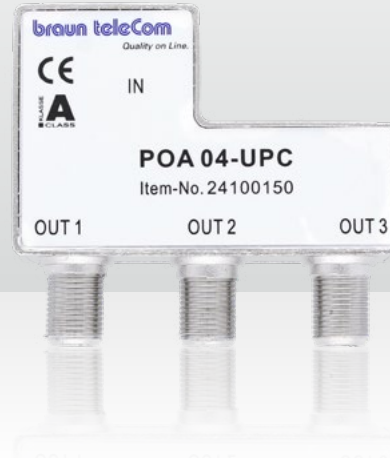

24100150
POA-04-UPC



- All connections with broadband ports 5 – 2.000 MHz
- Intermodulation resistant according to EN 60728-4
- High screening according to Class A +10 dB
- Suitable for mounting onto the TV-port of antenna outlets
- Surface coated with CuSn white bronze plating, thereby corrosion resistant

- Supplied with a protection plastic cap
- Versions with 2-port and 3-port as well as with IEC- and F-connections available
- POA-01-B: RF performance acc. to Kabelkeur PVE 5.0 Keurmerk

Parameter	Frequency [MHz]	POA-01-A	POA-01-B	POA-02-UPC	POA-03-UPC	POA-04-UPC	
Through loss [dB]	IN – PORT	5 – 12	4,0 ± 0,3	3,7 ± 0,3	4,0 ± 0,3	6,0 ± 0,5	6,0 ± 0,5
		12 – 470	3,8 ± 0,5	3,7 ± 0,3	3,8 ± 0,5	5,7 ± 0,3	5,7 ± 0,3
		470 – 860	4,0 ± 0,4	3,7 ± 0,3	4,0 ± 0,4	6,0 ± 0,5	6,0 ± 0,5
		860 – 1.006	4,0 ± 0,4	4,0 ± 0,4	4,0 ± 0,4	6,0 ± 0,5	6,0 ± 0,5
		1.006 – 1.218	4,6 ± 0,5	4,4 ± 0,5	4,6 ± 0,5	7,4 ± 0,5	7,4 ± 0,5
		1.218 – 1.700	4,6 ± 0,5	4,6 ± 0,5	4,6 ± 0,5	7,4 ± 0,5	7,4 ± 0,5
		1.700 – 2.000	5,2 ± 0,8	5,2 ± 0,8	5,2 ± 0,8	8,5 ± 1,5	8,5 ± 1,5
Isolation [dB]	PORT – PORT	5 – 15	≥ 25	≥ 20	≥ 25	≥ 25	≥ 25
		15 – 30	≥ 25	≥ 26	≥ 25	≥ 25	≥ 25
		30 – 470	≥ 30	≥ 26 -1,5 dB/Oct	≥ 30	≥ 25	≥ 25
		470 – 1.006	≥ 25	≥ 26 -1,5 dB/Oct	≥ 25	≥ 25	≥ 25
		1.006 – 1.218	≥ 20	≥ 26 -1,5 dB/Oct	≥ 20	≥ 20	≥ 20
		1.218 – 1.700	≥ 20	≥ 20	≥ 20	≥ 20	≥ 20
		1.700 – 2.000	≥ 15	≥ 15	≥ 15	≥ 15	≥ 15
Return loss [dB]	ALL	5 – 12	≥ 14	≥ 13	≥ 14	≥ 14	≥ 14
		12 – 40	≥ 16	≥ 20	≥ 16	≥ 16	≥ 16
		40 – 1.006	≥ 16	≥ 20 -1,5 dB/Oct	≥ 16	≥ 16	≥ 16
		1.006 – 1.218	≥ 14	≥ 20 -1,5 dB/Oct	≥ 14	≥ 14	≥ 14
		1.218 – 1.700	≥ 14	≥ 14	≥ 14	≥ 14	≥ 14
		1.700 – 2.000	≥ 12	≥ 12	≥ 12	≥ 12	≥ 12
		MoCA reduced isolation ⁽¹⁾ [dB max]	1.200 – 1.650	20	20	20	20
Intermodulation resistance [dBμV min] (acc. to IEC/EN 60728-4) ⁽²⁾		> 15	> 10 ⁽³⁾	> 15	> 15	> 15	
Number of output ports		2	2	2	3	3	
Connector type input		IEC-female	IEC-female	F-quickfix	IEC-female	F-quickfix	
Connector type outputs		IEC-male	IEC-male	F-female	IEC-male	F-female	
Integrated height adjustment of the protection plastic cap		No	No	Yes	Yes	Yes	
Order No.		24100002	24100003	24100050	24100100	24100150	

⁽¹⁾ With open input (accordant POE-Filter)

⁽²⁾ With 2 x 120 dBμV test signals f1 = 60 MHz and f2 = 65 MHz at all ports, IM2 = 2 x f1 + f1 + f2 + 2 x f2

⁽³⁾ With 2 x 115 dBμV test signals and after 1 kV pulse acc. to Kabelkeur PVE 5.0 Keurmerk

2-port push on adapters with band pass filter, IEC-male & F-female

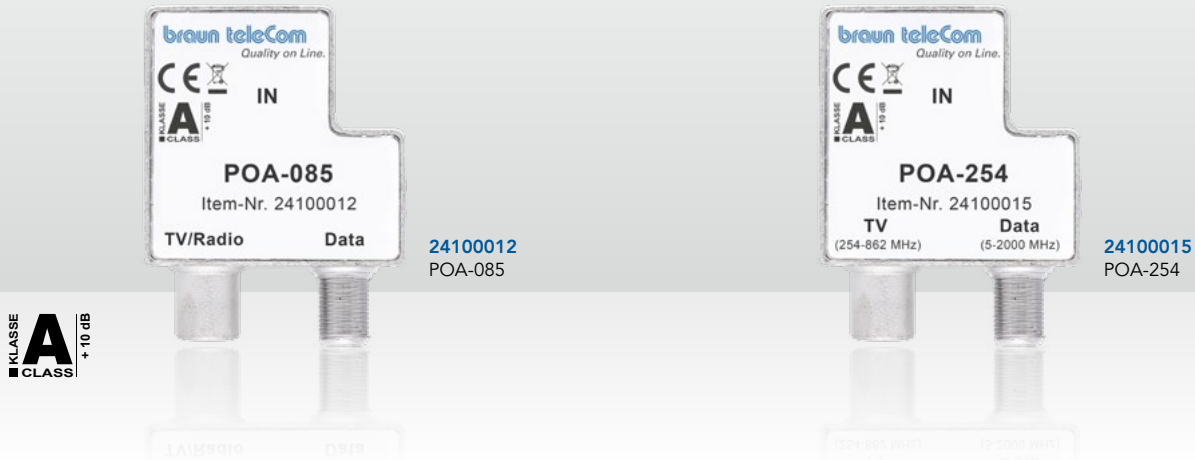

- Suitable for mounting onto antenna outlets with IEC-male at TV-port
- 1 input IEC-female at rear side
- 2 outputs, each one IEC-male and F-female
- Intermodulation resistant according to EN 60728-4 and after 1kV pulse applied at each port
- High screening according to EN 50083-2 Class A +10 dB
- Surface coated with CuSn white bronze plating, thereby corrosion resistant
- Supplied with a protection plastic cap (Pure white RAL 9010)
- TV/Radio-port (IEC-male) with band pass filter (specifications below)
- Data-port broadband 5 – 2.000 MHz

Parameter	Frequency [MHz]	POA-085	POA-254	
Insertion Loss [dB]	IN – TV/Radio	5 – 65	55 min. ⁽³⁾	60 typ., 55 min.
		65 – 204	4,7 + 0,3 ⁽²⁾	60 typ., 50 min.
		254 – 862	4,7 + 0,3 ⁽²⁾	4,7 + 0,3 ⁽⁴⁾
		950 – 2.000	55 min. ⁽⁵⁾	55 min. ⁽⁶⁾
Insertion Loss [dB]	IN – Data	5 – 862	3,7 + 0,3	3,7 + 0,3
		862 – 1.006	4,0 + 0,4	4,0 + 0,4
		1.006 – 1.218	4,4 + 0,5	4,4 + 0,5
		1.218 – 1.700	4,8 + 0,8	4,8 + 0,8
		1.700 – 2.000	5,5 + 1,0	5,5 + 1,3
Return Loss [dB]	IN	5 – 12	13 min.	13 min.
		12 – 65	20 min.	20 min.
		65 – 204	20 ⁽¹⁾	20 ⁽¹⁾
		254 – 862	20 ⁽¹⁾	20 ⁽¹⁾
		950 – 1.218	14 min.	14 min.
	1.218 – 2.000	14 typ., 12 min.	14 dB., 12 min.	
TV/Radio	85 – 254	20 ^{(1) (7)}	–	
	254 – 862	20 ^{(1) (7)}	20 dB ^{(1) (8)}	
Data	5 – 12	13 min.	13 min.	
	12 – 1.218	20 ⁽¹⁾	20 ⁽¹⁾	
	1.218 – 2.000	12 min.	12 min.	
Isolation [dB]	TV/Radio – Data	5 – 65	55 min. ⁽³⁾	60 typ., 55 min.
		65 – 204	35 typ. 30 min. ⁽⁹⁾	60 typ., 55 min. ⁽¹⁰⁾
		254 – 862	35 typ. 30 min. ⁽⁹⁾	35 typ. 30 min. ⁽⁹⁾
		950 – 2.000	55 min. ⁽⁵⁾	55 min. ⁽⁶⁾
Band pass filter at TV/Radio port [MHz]	Reject band 1	5 – 65	5 – 204	
	Pass band	85 – 862	254 – 862	
	Reject band 2	950 – 2.000	950 – 2.000	
Intermodulation [dBμV] ⁽¹¹⁾	after 25 V surge	≤ 10	≤ 10	
	after 1 KV surge	≤ 10	≤ 10	
Order No.		24100012	24100015	

⁽¹⁾ At 40 MHz -1.5 dB/Oct.

⁽²⁾ In frequency range 85 – 125 MHz with additional 0,5 dB loss; means 5,5 dB max.
In frequency range 750 – 800 MHz with additional 0,5 dB loss; means 5,5 dB max.
In frequency range 800 – 862 MHz with additional 2,0 dB loss; means 7,0 dB max.

⁽³⁾ In frequency range 50 – 65 MHz with additional 2,0 dB tolerances in mass production

⁽⁴⁾ In frequency range 254 – 260 MHz with additional 0,5 dB loss; means 5,5 dB max.

In frequency range 750 – 800 MHz with additional 0,5 dB loss; means 5,5 dB max.

In frequency range 800 – 862 MHz with additional 2,3 dB loss; means 7,3 dB max.

⁽⁵⁾ In frequency range 950 – 1000 MHz with additional 2,0 dB tolerances in mass production

⁽⁶⁾ In frequency range 950 – 1000 MHz with additional 5,0 dB tolerances in mass production

⁽⁷⁾ In frequency range 85 – 100 MHz with additional 2,0 dB tolerances in mass production

⁽⁸⁾ In frequency range 254 – 260 MHz with additional 2,0 dB tolerances in mass production

⁽⁹⁾ In frequency range 470 – 862 MHz with additional 2,0 dB tolerances in mass production

⁽¹⁰⁾ In frequency range 198 – 204 MHz with additional 2,0 dB tolerances in mass production

⁽¹¹⁾ With 2 carriers 60 & 65 MHz (115 dBμV) applied at OUT – OUT ports, according to EN 60728-4 and after 1 kV surge pulse at each port, intermodulation distortion level is ≤ 10 dBμV at 2 P = 120 MHz, at P + Q = 125 MHz, at 2 Q = 130 MHz.

2-port and 3-port push on adapters up to 2 GHz with selective radio-port



24100005
POA-1-IEC-NL



24100105
POA-3-IEC-NL



- Intermodulation resistant according to EN 60728-4
- High screening according to Class A +10 dB
- Suitable for mounting onto antenna outlets with IEC-male at TV-port
- Surface coated with CuSn white bronze plating, thereby corrosion resistant

- Supplied with a protection plastic cap
- TV and DATA-ports with FM filter, therefore transmission range 5 – 65 & 120 – 2.000 MHz (no FM, S 2 and S 3)

Parameter	Frequency [MHz]	POA-1-IEC-NL	POA-3-IEC-NL	
Through loss [dB]	IN – TV (IN – DATA)	5 – 65	0,7 ± 0,5	4,6 ± 0,5
		65 – 120	> 20 typ.	> 20 typ.
		120 – 1.218	0,7 ± 0,5	4,6 ± 0,5
		1.218 – 1.700	1,3 ± 0,5	6,2 ± 0,5
		1.700 – 2.000	1,7 ± 0,5	7,2 ± 0,5
Isolation [dB]	IN – FM	87,5 – 108	2,0 ± 0,5	2,0 ± 0,5
		5 – 65	≥ 25	≥ 32
	TV – FM (DATA – FM)	65 – 120	–	–
		120 – 470	≥ 20	≥ 20
		470 – 1.218	≥ 25	≥ 25
		1.218 – 1.700	≥ 22	≥ 25
		1.700 – 2.000	≥ 20	≥ 25
	(TV – DATA)	5 – 15	–	≥ 20
		15 – 65	–	≥ 30
		65 – 120	–	–
120 – 1.218		–	≥ 20	
1.218 – 1.700		–	≥ 16	
1.700 – 2.000		–	≥ 14	
Return loss [dB]	IN	5 – 12	≥ 14	≥ 18
		12 – 65	≥ 16	≥ 18
		87,5 – 108	≥ 16	≥ 15
		108 – 1.006	≥ 16	≥ 18*
		1.006 – 2.000	14 typ.	≥ 18*
	TV (DATA)	5 – 12	≥ 14	≥ 18
		12 – 65	≥ 16	≥ 18
		120 – 1.006	≥ 16	≥ 18*
		1.006 – 2.000	14 typ	≥ 18*
		FM	87,5 – 108	15 typ
Intermodulation ⁽¹⁾ (dBµV min)		115	115	
Amount ports		2	3	
TV-port		5 – 65 MHz 120 – 2.000 MHz (IEC-male)	5 – 65 MHz 120 – 2.000 MHz (IEC-male)	
Radio-port (selective)		87 – 108 MHz (IEC-female)	87 – 108 MHz (IEC-female)	
DATA-port		–	5 – 65 MHz 120 – 2.000 MHz (F-female)	
Order No.		24100005	24100105	

⁽¹⁾ With test signals P = 60 MHz, Q = 65 MHz applied at DATA, TV OUT respectively, intermodulation distortion level is ≤ 15 dBuV at 2 P = 120 MHz, at P + Q = 125 MHz, at 2 Q = 130 MHz

* f > 40 MHz -1,5 dB/Oct, min. > 12 dB

3-port SAT antenna outlet

SMATV antenna outlet with frequency range 4 – 2.400 MHz

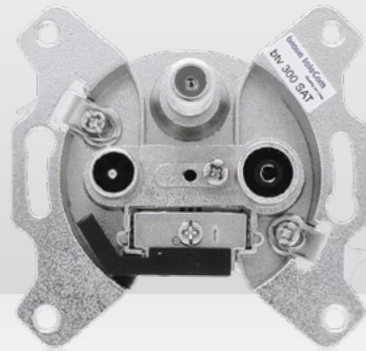

21030000
btv-300-SAT



- Special satellite TV-port (F-female) for the separate connection of a satellite receiver
- Qualified for digital transmission and for a combined transmission of satellite, terrestrial and/or cable TV signals (also S2 and S3)
- Qualified for reverse path transmission, via TV- or RF-port
- TV- and RF-ports designed as broadband ports with equal tap loss on TV and RF
- DC-Powerpass via SAT-port for LNB-powering (incl. 22 kHz- and DiSEqC-signal)
- Very high isolation between TV/RF-port and SAT-port
- Galvanic isolation of the inner conductors at TV- and RF-Port against hum modulation and leakage currents
- Screening according EN 50083-2 Class A:
 - > 84 dB (30 – 300 MHz)
 - > 80 dB (300 – 470 MHz)
 - > 75 dB (470 – 1.000 MHz)
 - > 55 dB (1.000 – 2.400 MHz)
- Cover plate SAD-155, 80 x 80 mm, color Pure white RAL 9010, will be delivered together with the outlet (Order No. 22080600)
- Surface-mount frame SAD-165, 80 x 80 x 33 mm, color Pure white RAL 9010 (Order No. 22080800)

Parameter	Frequency [MHz]	btv-300-SAT	
Tap loss [dB]	TV	4 – 40	4,0 ± 1,0
		40 – 470	3,5 ± 1,0
		470 – 862	4,5 ± 1,0
	RF	4 – 40	4,0 ± 1,0
		40 – 470	3,5 ± 1,0
		470 – 862	4,5 ± 1,0
SAT	950 – 2.150	1,5 ± 1,0	
	2.150 – 2.400	2,5 ± 1,0	
Isolation [dB]	TV – RF	4 – 862	> 20 typ.
		950 – 2.400	> 20 typ.
	TV – SAT	4 – 862	> 20 typ.
		950 – 2.400	> 20 typ.
	RF – SAT	4 – 862	> 20 typ.
		950 – 2.400	> 20 typ.
Return loss	TV	> 14 dB -1,5 dB/oct. (> 10 dB min.)	
	RF	> 14 dB -1,5 dB/oct. (> 10 dB min.)	
	SAT	> 10 dB decreasing linearly to 7,2 dB	
Order No.		21030000	

3-port multimedia antenna outlets

Selective multimedia outlet with 5 – 65 MHz reverse path

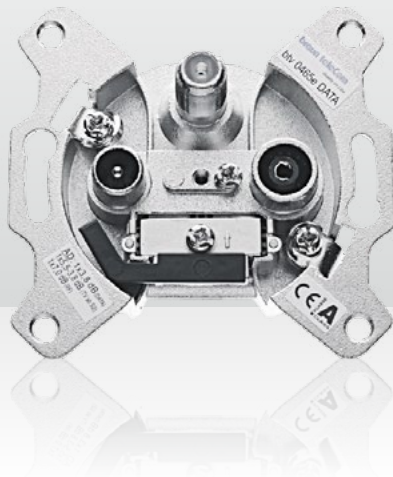

221500000
btv-0465e DATA



22080600
SAD-155



- Special DATA-port (F-female) for the separate connection of a cable modem
- Selective separation of TV and radio frequency ranges by high rejection filters on TV- and RF-port
- Very high isolation between TV and DATA-port to avoid influences of TV-IF frequency by ingress of reverse signals
- Galvanic isolation protection against hum modulation and leakage currents (only inner conductors)
- **Transmission of channels S2 and S3!**
- Screening according EN 50083-2 Class A:
 - > 85 dB (30 – 300 MHz),
 - > 80 dB (300 – 470 MHz),
 - > 75 dB (470 – 862 MHz)
- Cover plate SAD-155, 80 x 80 mm, color Pure white RAL 9010, will be delivered together with the multimedia outlets (Order No. 22080600)
- Surface-mount frame SAD-165, 80 x 80 x 33 mm, color Pure white RAL 9010, for multimedia outlets (Order No. 22080800)

Parameter		Frequency [MHz]	btv-0465e DATA	
Tap loss [dB]	DATA	5 – 862	3,8 ± 0,5	
		862 – 1.000	3,8 ± 0,8	
	TV	5 – 65	> 60 typ.	
		87,5 – 108	> 10 typ.	
		109 ¹⁾ – 125	5,4 ± 1,0	
	RF	125 – 1.000	3,8 ± 0,5	
		5 – 65	> 35 typ.	
		87,5 – 108	7,5 ± 1,0 ²⁾	
		109 – 125	> 12 typ.	
125 – 1.000		> 25 typ.		
Isolation [dB]		DATA – TV	5 – 65	> 70
	65 – 300		> 30	
	300 – 1.000		> 25	
	DATA – RF	5 – 65	> 60	
		65 – 300	> 30	
		300 – 1.000	> 28	
	TV – RF	87,5 – 108	> 12	
		111 – 125	> 12	
		125 – 300	> 35	
	Return loss	DATA		> 18 dB -1,5 dB/oct.
		TV		> 12,5 dB f = 111 MHz
		RF		> 10 dB
Order No.			21500000	

¹⁾ Additionally 2,0 dB at 109 MHz

²⁾ Additionally 0,5 dB at the filter edges possible

Multimedia antenna outlets with 5 – 65 MHz return path

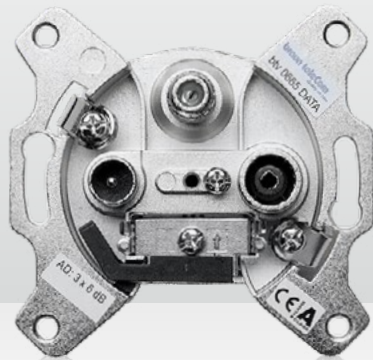

21900000
btv-0665-DATA

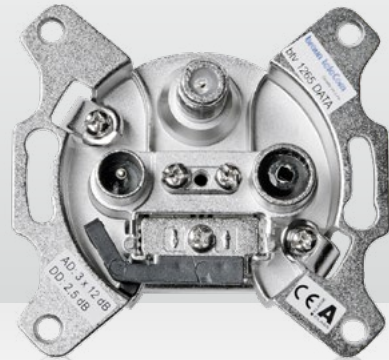

21920001
btv-1265-DATA-IM



Parameter	Frequency [MHz]	End outlet							
		btv-0665-DATA	btv-1165-DATA-IM	btv-1265-DATA-IM	btv-1465-DATA	btv-1565-DATA	btv-1765-DATA	btv-1965-DATA	
IN – OUT	5 – 65	–	3,8 ± 0,8	2,5 ± 0,8	1,8 ± 0,8	2,0 ± 0,8	1,5 ± 0,8	1,0 ± 0,8	
	87,5 – 108	–	3,8 ± 0,8	2,5 ± 0,8	1,8 ± 0,8	2,0 ± 0,8	1,5 ± 0,8	1,0 ± 0,8	
	109 – 1.006	–	3,8 ± 0,8	2,5 ± 0,8	1,8 ± 0,8	2,0 ± 0,8	1,5 ± 0,8	1,0 ± 0,8	
TV	5 – 65	60 typ.	60,0 typ.	60,0 typ.	60,0 typ.	60,0 typ.	60,0 typ.	60,0 typ.	
	87,5 – 108	6,0 ± 1,0	10,0 ± 1,0	12,0 ± 1,0	14,0 ± 1,0	15,5 ± 1,0	17,0 ± 1,0	19,0 ± 1,0	
	109 – 1.006	6,0 ± 1,0	10,0 ± 1,0	12,0 ± 1,0	14,0 ± 1,0	15,5 ± 1,0	17,0 ± 1,0	19,0 ± 1,0	
Radio	5 – 65	60 typ.	60,0 typ.	60,0 typ.	60,0 typ.	60,0 typ.	60,0 typ.	60,0 typ.	
	87,5 – 108	6,0 ± 1,0	10,0 ± 1,0	12,0 ± 1,0	14,0 ± 1,0	15,5 ± 1,0	17,0 ± 1,0	19,0 ± 1,0	
	109 – 1.006	6,0 ± 1,0	10,0 ± 1,0	12,0 ± 1,0	14,0 ± 1,0	15,5 ± 1,0	17,0 ± 1,0	19,0 ± 1,0	
DATA	5 – 65	6,5 ± 1,0	10,0 ± 1,0	12,0 ± 1,0	14,0 ± 1,0	15,5 ± 1,0	17,0 ± 1,0	19,0 ± 1,0	
	87,5 – 108	6,5 ± 1,0	10,0 ± 1,0	12,0 ± 1,0	14,0 ± 1,0	15,5 ± 1,0	17,0 ± 1,0	19,0 ± 1,0	
	109 – 1.006	6,5 ± 1,0	10,0 ± 1,0	12,0 ± 1,0	14,0 ± 1,0	15,5 ± 1,0	17,0 ± 1,0	19,0 ± 1,0	
IN – OUT	5 – 65	–	3,8 ± 0,8	2,5 ± 0,8	1,8 ± 0,8	2,0 ± 0,8	1,5 ± 0,8	1,0 ± 0,8	
	84 – 470	–	3,8 ± 0,8	2,5 ± 0,8	1,8 ± 0,8	2,0 ± 0,8	1,5 ± 0,8	1,0 ± 0,8	
	470 – 1.006	–	3,8 ± 0,8	2,5 ± 0,8	1,8 ± 0,8	2,0 ± 0,8	1,5 ± 0,8	1,0 ± 0,8	
IN – DATA	5 – 65	6,5 ± 1,0	10,0 ± 1,0	12,0 ± 1,0	14,0 ± 1,0	15,5 ± 1,0	17,0 ± 1,0	19,0 ± 1,0	
	84 – 470	6,5 ± 1,0	10,0 ± 1,0	12,0 ± 1,0	14,0 ± 1,0	15,5 ± 1,0	17,0 ± 1,0	19,0 ± 1,0	
	470 – 1.006	6,5 ± 1,0	10,0 ± 1,0	12,0 ± 1,0	14,0 ± 1,0	15,5 ± 1,0	17,0 ± 1,0	19,0 ± 1,0	
IN – TV	5 – 65	60 typ.	60 typ.	60 typ.	60 typ.	60 typ.	60 typ.	60 typ.	
	84 – 470	6,0 ± 1,0	10,0 ± 1,0	12,0 ± 1,0	14,0 ± 1,0	15,5 ± 1,0	17,0 ± 1,0	19,0 ± 1,0	
	470 – 1.006	6,0 ± 1,0	10,0 ± 1,0	12,0 ± 1,0	14,0 ± 1,0	15,5 ± 1,0	17,0 ± 1,0	19,0 ± 1,0	
IN – Radio	5 – 65	60 typ.	60 typ.	60 typ.	60 typ.	60 typ.	60 typ.	60 typ.	
	84 – 470	6,0 ± 1,0	10,0 ± 1,0	12,0 ± 1,0	14,0 ± 1,0	15,5 ± 1,0	17,0 ± 1,0	19,0 ± 1,0	
	470 – 1.006	6,0 ± 1,0	10,0 ± 1,0	12,0 ± 1,0	14,0 ± 1,0	15,5 ± 1,0	17,0 ± 1,0	19,0 ± 1,0	
DATA – TV	5 – 65	> 70	≥ 70	≥ 70	≥ 70	≥ 70	≥ 70	≥ 70	
	84 – 300	≥ 30	≥ 36	≥ 42	≥ 42	≥ 42	≥ 42	≥ 42	
	300 – 862	≥ 36	≥ 36	≥ 36	≥ 36	≥ 36	≥ 36	≥ 36	
DATA – Radio	5 – 65	> 30	≥ 36	≥ 42	≥ 42	≥ 42	≥ 42	≥ 42	
	84 – 862	> 30	≥ 36	≥ 42	≥ 42	≥ 42	≥ 42	≥ 42	
	862 – 1.006	> 30	≥ 26	≥ 30	≥ 30	≥ 30	≥ 30	≥ 30	
TV – Radio	87,5 – 1.006	> 25	≥ 25	≥ 25	≥ 25	≥ 20	≥ 20	≥ 20	
	5 – 65	–	≥ 35	≥ 30	≥ 35	≥ 40	≥ 40	≥ 40	
	84 – 300	–	≥ 30	≥ 30	≥ 30	≥ 32	≥ 32	≥ 32	
OUT – DATA	300 – 862	–	≥ 26	≥ 30	≥ 30	≥ 26	≥ 30	≥ 30	
	862 – 1.006	–	≥ 26	≥ 26	≥ 26	≥ 26	≥ 26	≥ 26	
	5 – 65	–	≥ 65	≥ 65	≥ 65	≥ 65	≥ 65	≥ 65	
OUT – TV	84 – 862	–	≥ 30	≥ 30	≥ 30	≥ 32	≥ 32	≥ 32	
	862 – 1.006	–	≥ 25	≥ 30	≥ 30	≥ 32	≥ 32	≥ 32	
	5 – 65	–	≥ 70	≥ 70	≥ 70	≥ 70	≥ 70	≥ 70	
OUT – Radio	84 – 862	–	≥ 30	≥ 30	≥ 30	≥ 30	≥ 30	≥ 30	
	862 – 1.006	–	≥ 25	≥ 30	≥ 30	≥ 30	≥ 30	≥ 30	
	5 – 10	≥ 14	≥ 14	≥ 14	≥ 14	≥ 14	≥ 14	≥ 14	
Return loss [dB]	10 – 1.006	> 18*	> 18*	> 18*	> 18*	> 18*	> 18*	> 18*	
	DATA	> 18*	> 18*	> 18*	> 18*	> 18*	> 18*	> 18*	
	TV	> 14,0**	> 14,0**	> 14,0**	> 14,0**	> 14,0**	> 14,0**	> 14,0**	
Radio	84 – 1.006	> 10,0	> 10	> 10	> 10	> 14,0**	> 14,0**	> 14,0**	
Order No.		21900000	21910001	21920001	21930000	21930015	21930017	21930019	

- Special DATA-port (F-female) for the separate connection of a cable modem
- TV- and RF-ports designed as broadband ports with equal through loss on TV and RF
- Very high isolation between TV and DATA to avoid influences of TV-IF frequency by ingress of reverse signals
- Galvanic isolation protection against hum modulation and leakage currents (inner conductors only)
- Screening according EN 50083-2 Class A: > 85 dB (5 – 300 MHz), > 80 dB (300 – 470 MHz), > 75 dB (470 – 862 MHz)
- Cover plate SAD-155, 80 x 80 mm, color Pure white RAL 9010, will be delivered together with the multimedia outlets (Order No. 22080600)
- Surface-mount frame SAD 165, 80 x 80 x 33 mm, color Pure white RAL 9010, for multimedia outlets (Order No. 22080800)

* f = 40 MHz -1,5 dB/Oct.
** f = 109 MHz -1,5 dB/Oct.

4-port multimedia/SAT antenna outlets

with an additional SAT-port, 5 – 65 MHz reverse path

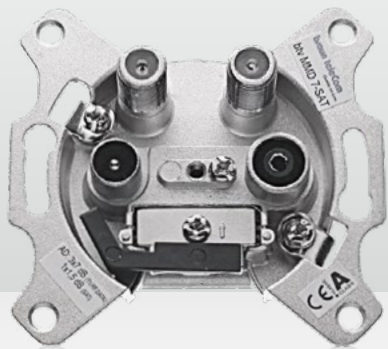

21940700
btv-MMD-7-SAT

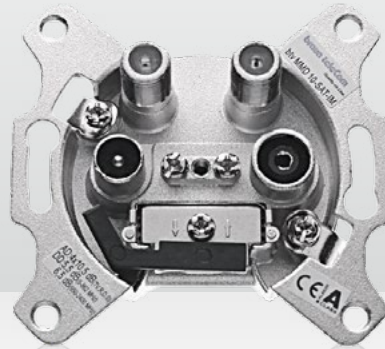

21940711
btv-MMD-10-SAT-IM



- Specially designed for operations in satellite IF distribution networks in combination with multimedia applications
- Special SAT-port (F-female) 950 – 2.400 MHz for the separate connection of a satellite receiver
- DC Powerpass SAT to IN for LNB powering 500 mA max. including 22 kHz and DiSEqC signals
- Special DATA-port (F-female) for the separate connection of a cable modem
- TV- and RF-ports designed as broadband ports with equal tap loss on TV and RF
- Very high isolation between TV/RF and DATA-port to avoid influences of TV-IF frequency by ingress of reverse signals
- Galvanic isolation protection of TV-, RF- and DATA-port against hum modulation and leakage currents (inner conductors only)
- Intermodulation resistant according to DIN EN 60728-4
- Screening according EN 50083-2 Class A:
 - > 85 dB (30 – 300 MHz),
 - > 80 dB (300 – 470 MHz),
 - > 75 dB (470 – 862 MHz)
- Cover plate SAD-401, 80 x 80 mm, color Pure white RAL 9010, will be delivered together with the multimedia outlets (Order No. 22090401)
- Surface-mount frame SAD-165, 80 x 80 x 33 mm, color Pure white RAL 9010, for multimedia outlets (Order No. 22080800)

Parameter	Frequency [MHz]	End outlet		Loop-through outlets		
		btv-MMD-7-SAT	btv-MMD-10-SAT-IM	btv-MMD-14-SAT-IM	btv-MMD-19-SAT-IM	
Through loss [dB]	IN – OUT	5 – 862	–	5,5 ± 1	3,5 ± 1	2 ± 1
		950 – 2150	–	6,5 ± 1	4,8 ± 1	2,7 ± 1
		2.150 – 2.400	–	9,5 max.	7,5 max.	4,7 max.
Tap loss [dB]	IN – SAT	950 – 970	1,5 ± 1	10,5 ± 1,5	14,5 ± 1,5	19,5 ± 1,5
		970 – 2.150	1,5 ± 1	10,5 ± 1	14,5 ± 1	19,5 ± 1
		2.150 – 2.400	1,5 ± 1	12,5 max.	16 max.	21 max.
	IN – DATA	5 – 862	7 ± 1	10,5 ± 1	14 ± 1	19,5 ± 1
	IN – TV	5 – 65	55 typ. 50 min.	60 typ. 50 min.	60 typ. 50 min.	60 typ. 50 min.
	IN – R	84 – 470	7,0 ± 1	10,5 ± 1	14 ± 1	20 ± 1
Isolation [dB]	OUT – DATA	470 – 862	7,0 ± 1,5	10,5 ± 1	14 ± 1	20 ± 1
		5 – 15	–	22 min.	22 min.	28 min.
		15 – 65	–	28 min.	27 min.	32 min.
	OUT – TV	84 – 862	–	22 min.	26 min.	26 min.
		5 – 65	–	55 min.	55 min.	55 min.
		84 – 470	–	30 min.	23 min.	25 min.
	OUT – Radio	470 – 862	–	22 min.	22 min.	22 min.
		950 – 2.400	–	18 min.	18 min.	18 min.
		TV – Radio	84 – 862	20 min.	20 min.	20 min.
	TV/R – DATA	5 – 65	70 typ. 60 min.	70 typ. 60 min.	70 typ. 60 min.	70 typ. 60 min.
		84 – 470	25 min.	40 min.	35 min.	40 min.
		470 – 862	25 min.	25 min.	28 min.	30 min.
DATA/TV/R – SAT	5 – 65	65 typ. 50 min.	65 typ. 50 min.	65 typ. 50 min.	65 typ. 50 min.	
	84 – 470	30 min.	30 min.	30 min.	30 min.	
	470 – 862	15 min.	15 min.	15 min.	15 min.	
	950 – 2.400	10 min.	10 min.	10 min.	10 min.	
IN	5 – 15	14 min.	14 min.	14 min.	14 min.	
	15 – 65	16 min.	14 min.	16 min.	16 min.	
	84 – 862	18*	18*	18*	18*	
	950 – 2.400	10, decreasing linearly to 7,2				
	SAT	950 – 2.400	10, decreasing linearly to 7,2			
Return loss [dB]	5 – 10	18*	10 min.	18 min.	18 min.	
	10 – 65	18*	10 min.	18*	18*	
	DATA	84 – 120	18*	12 min.	18*	18*
		120 – 160	18*	14 min.	18*	18*
		160 – 862	18*	18*	18*	18*
	TV, R	84 – 862	14**, but > 10	14**, but > 10	14**, but > 10	14**, but > 10
DC pass	SAT → IN, OUT ↔ IN	24 VDC, 500 mA max. + 22 KHz + DiSEqC				
Order No.		21940700	21940711	21940715	21940720	

* f = 40 MHz -1,5 dB/oct.

** f = 109 MHz -1,5 dB/oct.

4-port multimedia antenna outlets

with 2 separate DATA-ports and 5 – 65 MHz reverse path

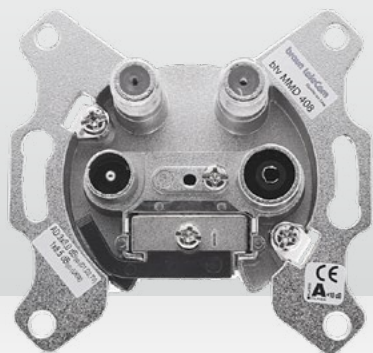

21933408
btv-MMD-408

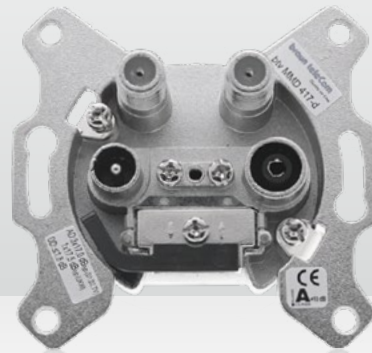

21933417
btv-MMD-417-d



Parameter	Frequency [MHz]	Termination/end outlet		Loop-through outlets						
		btv-MMD-408	btv-MMD-412T	btv-MMD-412-d	btv-MMD-415-d	btv-MMD-415-HPF	btv-MMD-417-d	btv-MMD-420-d		
Insertion loss [dB]	IN – OUT	5 – 65	–	–	3 ± 1	1,7 ± 0,8	45 min.	1,1 ± 0,5	0,9 ± 0,5	
		65 – 470	–	–	3 ± 1	1,7 ± 0,8	2 ± 1	1,1 ± 0,5	0,9 ± 0,5	
		470 – 862	–	–	3 ± 1	1,7 ± 0,8	2 ± 1	1,1 ± 0,5	0,9 ± 0,5	
		862 – 1.006	–	–	3,5 ± 1	1,8 ± 1	2,2 ± 1	1,1 ± 0,7	0,9 ± 0,7	
		1.006 – 1.218	–	–	4 ± 1	2,5 ± 1	2,6 ± 1	1,4 ± 1	1,1 ± 1	
Tap loss [dB]	DATA	5 – 470	8 ± 1	12 ± 1	12 ± 1	15 ± 1	15 ± 1	17 ± 1	20 ± 1	
		470 – 862	8 ± 1	12 ± 1	12 ± 1	15 ± 1	15 ± 1	17 ± 1	20 ± 1	
		862 – 1.006	8 ± 1	12 ± 1	12 ± 1	15 ± 1	15 ± 1	17 ± 1	20 ± 1	
		1.006 – 1.218	8,5 ± 1	12 ± 1	12 ± 1	15 ± 1	15,5 ± 1	17 ± 1	20 ± 1	
	TV	5 – 65	52 min.	52 min.	52 min.	52 min.	52 min.	52 min.	52 min.	
		109 – 470	8 ± 1	12 ± 1	12 ± 1	15 ± 1	15 ± 1	17 ± 1	20 ± 1	
		470 – 862	8 ± 1	12 ± 1	12 ± 1	15 ± 1	15 ± 1	17 ± 1	20 ± 1	
		862 – 1.006	8 ± 1	12 ± 1	12 ± 1	15 ± 1	15 ± 1	17 ± 1	20 ± 1	
		1.006 – 1.218	9 ± 1	12,5 ± 1	12,5 ± 1	15,5 ± 1	15 ± 1	17 ± 1	20 ± 1	
	Radio	5 – 65	52 min.	52 min.	52 min.	52 min.	52 min.	52 min.	52 min.	
		87,5 – 108	8,5 ± 1	12,5 ± 1	12,5 ± 1	15,5 ± 1	15,5 ± 1	17,5 ± 1	20,5 ± 1	
		126 – 140	24 min	24 min	24 min	24 min	24 min	28 min.	30 min.	
		140 – 862	35 min.	35 min.	35 min	35 min	35 min	35 min	35 min	
		1.006 – 1.218	35 min.	35 min.	35 min.	35 min.	35 min	35 min	35 min	
TV – DATA, Radio – DATA	5 – 65	60 min.	60 min.	60 min.	60 min.	60 min.	60 min.	60 min.		
	65 – 1.218	30 min.	30 min.	30 min.	30 min.	30 min.	30 min.	30 min.		
Isolation [dB]	OUT – DATA	5 – 65	–	–	30 min.	32 min.	35 min.	32 min.	32 min.	
		87,5 – 862	–	–	26 min.	26 min.	26 min.	26 min.	26 min.	
		862 – 1.006	–	–	24 min.	24 min.	26 min.	26 min.	26 min.	
		1.006 – 1.218	–	–	22 min.	22 min.	26 min.	26 min.	24 min.	
	OUT – TV, OUT – RADIO	5 – 65	–	–	55 min.	55 min.	55 min.	55 min.	55 min.	
		87,5 – 470	–	–	24 min.	26 min.	30 min.	26 min.	26 min.	
		470 – 862	–	–	24 min.	26 min.	24 min.	26 min.	26 min.	
		862 – 1.006	–	–	22 min.	24 min.	22 min.	24 min.	24 min.	
		1.006 – 1.218	–	–	20 min.	20 min.	20 min.	22 min.	22 min.	
DATA – DATA	5 – 15	35 min.	35 min.	35 min.	35 min.	32 min	35 min.	35 min.		
	15 – 80	35 min.	35 min.	35 min.	35 min.	35 min	35 min.	35 min.		
	80 – 160	33,5 min.	33,5 min.	33,5 min.	33,5 min.	33 min	33,5 min.	33,5 min.		
	160 – 320	32 min.	32 min.	32 min.	32 min.	32 min	32 min.	32 min.		
	320 – 640	30,5 min.	30,5 min.	30,5 min.	30,5 min.	30 min.	30,5 min.	30,5 min.		
	640 – 862	28 min.	28 min.	28 min.	28 min.	28 min	28 min.	28 min.		
	862 – 1.006	28 min.	28 min.	28 min.	28 min.	28 min	28 min.	28 min.		
	1.006 – 1.218	20 min	20 min.	20 min.	20 min.	20 min.	20 min.	20 min.		
Return loss [dB]	IN	5 – 60	≥ 14*	≥ 14*	≥ 18*	≥ 18*	≥ 18*	≥ 18*	≥ 18*	
		60 – 65	≥ 14*	≥ 14*	≥ 18*	≥ 18*	16,5	≥ 18*	≥ 18*	
		87,5 – 1.218	≥ 14*	≥ 14*	≥ 18*	≥ 18*	≥ 18*	≥ 18*	≥ 18*	
	OUT	87,5 – 1.218	–	–	≥ 18*	≥ 18*	16,5**	≥ 18*	≥ 18*	
		DATA	5 – 1.218	≥ 18*	≥ 18*	≥ 18*	≥ 18*	≥ 18*	≥ 18*	
		TV	109 – 1.218	≥ 14**	≥ 14**	≥ 14**	≥ 14**	≥ 14**	≥ 14**	≥ 14**
		TV	109 – 1.218	≥ 14**	≥ 14**	≥ 14**	≥ 14**	≥ 14**	≥ 14**	≥ 14**
		Radio	87,5 – 108	≥ 10	≥ 10	≥ 10	≥ 10	≥ 10	≥ 10	≥ 10
Order No.		21933408	21933411	21933412	21933415	21933414	21933417	21933420		

- 2 separate DATA-ports (F-females) for the direct connection of an interactive Set-Top-Box respectively PVR and a cable modem
- Very high isolation between TV/RF and the DATA-ports to avoid influences of TV-IF frequency by ingress of reverse signals, very high isolation between the DATA-ports in the reverse path range
- Galvanic isolation protection of TV-, RF- and DATA-ports against hum modulation and leakage currents (inner conductors only)
- Increased intermodulation resistance at 150 VDC/ 115 VAC/50 Hz surge in compliance with EN 60828-4
- Max. IM2 products ≤ 15 dBμV before and after surge hit (two return path signals 60 MHz and 65 MHz with 120 dBμV each)
- Screening according EN 50083-2 Class A +10 dB
- Cover plate SAD-400, 80 x 80 mm, color Pure white RAL 9010, will be delivered together with the multimedia outlets (Order No. 22090400)
- Surface-mount frame SAD-165, 80 x 80 x 33 mm, color Pure white RAL 9010, for multimedia outlets not included (Order No. 22080800)

* f = 40 MHz -1,5 dB/Oct.
** f = 80 MHz -1,5 dB/Oct.

Accessories

Cover plates, surface-mount frames and terminal resistors



Cover plates 1-piece for antenna wall outlets

Parameter	SAD-122	SAD-155	SAD-157	SAD-158
Suitable for outlet	2-port multimedia outlets btv-MMD-5xx & -6xx	3-port multimedia outlets btv-xxxx-DATA	4-port multimedia SAT outlets btv-MMD-xx-SAT	4-port multimedia outlets btv-MMD-xxx
Imprint	TV/DATA	TV/R/DATA	TV/R/DATA/SAT	TV/R/DATA/DATA
Suitable for surface-mount frame	SAD-165			
Color	Pure white RAL 9010			
Dimensions [mm]	80 x 80			
Order No.	22080122	22080600	22080700	22080701

Cover plates 2-piece for antenna wall outlets

Parameter	SAD-202	SAD-300	SAD-303	SAD-400	SAD-400
Suitable for outlet	2-port multimedia outlets btv-MMD-5xx & -6xx	3-port multimedia outlets btv-xxxx-DATA	3-port multimedia outlets btv-3xx-y-HQ	4-port multimedia outlets btv-MMD-xxx	4-port multimedia outlets btv-MMD-xxx
Imprint	TV/DATA	TV/R/DATA	TV/R/DATA	TV/R/DATA/DATA	TV/R/DATA
Suitable for surface-mount frame	SAD-165				
Color	Pure white RAL 9010				
Dimensions [mm]	80 x 80				
Faceplate dimensions [mm]	50 x 50				
Order No.	22090202	22090300	22090303	22090400	22090400

Surface-mount frame

SAD-165, 80 x 80 x 33 mm, color Pure white RAL 9010

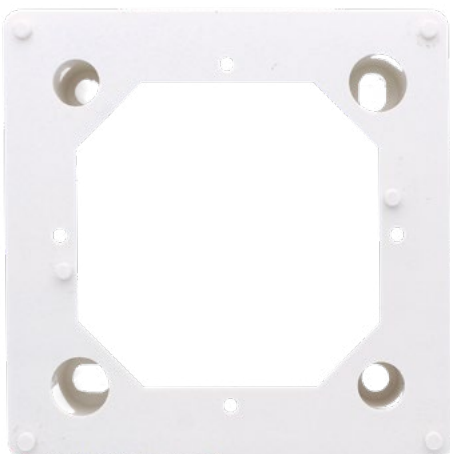

Order No. 22080800

Terminal resistors 75 Ω for antenna wall outlets

SAW-75

Diameter approximately 5 mm

Order No. 22030000

SAX-75

Diameter approximately 4 mm

Order No. 22030100

Subscriber connection cables

Connection cables with IEC and F-male connectors



IEC subscriber cables

Receiver leads for CATV house distribution with IEC male and IEC female connectors. To secure the measured screening in practice the receiver leads must have a bending radius of min. 10 cm to avoid a permanent damage of the screen and a worsening of the screening!

Item	Connectors	Length [m]	Color	Compliant with KDG 1 TS 152	Order No.
FK-2-1.5-H	IEC-male and female	1,5	White	Yes	22210115
FK-2-2.0-H	IEC-male and female	2,0	White	Yes	22210120
TAK-1,5-IEC	IEC-male and female	1,5	White	No	22210130
TAK-2,5-IEC	IEC-male and female	2,5	White	No	22210131
TAK-3,5-IEC	IEC-male and female	3,5	White	No	22210132
TAK-5,0-IEC	IEC-male and female	5,0	White	No	22210133
TAK-7,5-IEC	IEC-male and female	7,0	White	No	22210134
TAK-10,0-IEC	IEC-male and female	10,0	White	No	22210136

Fm/Fm modem subscriber cables

Modem subscriber cable with F-male connectors to connect a cable modem on the DATA-port of a multimedia antenna outlet. To secure the measured screening in practice the receiver leads must have a bending radius of min. 10 cm to avoid a permanent damage of the screen and a worsening of the screening!

The subscriber connection cables MAK-XXX-90 are composed of two EX 6-49/83 connectors (brand PPC) and an Oren HD-103 coaxial cable.

Item	Connectors	Length [m]	Color	Order No.
MAK-1,5-FM	2 x screwable F-male	1,5	White	22210216
MAK-2,5-FM	2 x screwable F-male	2,5	White	22210226
MAK-150-90	2 x screwable F-male	1,5	White	22280704
MAK-250-90	2 x screwable F-male	2,5	White	22280705
MAK-350-90	2 x screwable F-male	3,5	White	22280706
MAK-500-90	2 x screwable F-male	5,0	White	22280707

We do not have the perfect connection cable in our product portfolio yet?

We are happy to produce connection cables according to your requirements, even in small quantities!

Connection cables with F-Quickfix-male



- For the connection of terminal devices on multimedia outlets
- According to VF TS 5001
- Screening according to EN 60966-2-7, Class A +20 dB
- 4-way screened; 4G/5G-protected

- DOCSIS 4.0 ready
- White, in a polybag with SB-sealing card
- Color coded
- Vodafone listed

Parameter	Frequency [MHz]	EAK-151-80	EAK-201-80	EAK-251-80	EAK-301-80	EAK-501-80	EAK-601-80	EAK-901-80
Impedance [Ω]		75						
Frequency range [MHz]		0 – 1.800						
Attenuation [dB]	100	< 0,14	< 0,17	< 0,21	< 0,25	< 0,40	< 0,50	< 0,70
	500	< 0,38	< 0,40	< 0,56	< 0,65	< 1,00	< 1,20	< 1,76
	862	< 0,54	< 0,60	< 0,79	< 0,91	< 1,40	< 1,64	< 2,38
	1.000	< 0,60	< 0,70	< 0,87	< 1,01	< 1,55	< 1,82	< 2,62
	1.500	< 0,80	< 0,80	< 1,13	< 1,29	< 1,95	< 2,28	< 3,28
	1.800	< 0,91	< 0,90	< 1,28	< 1,46	< 2,20	< 2,56	< 3,66
Return loss [dB]	5 – 1.000	≥ 20						
	1.000 – 1.800	≥ 18						
Screening [dB]	30 – 1.000	≥ 105						
	1.000 – 1.800	≥ 95						
Transfer impedance [mΩ/m]	5 – 30	< 0,9						
connector 1		F-Quickfix-male (straight) acc. to IEC 61169-47						
connector 2		F-Quickfix-male (straight) acc. to IEC 61169-47						
design		with bend protection covers						
Length [m]		1,5	2	2,5	3	5	6	9
Order-No.		85015180	85020180	85025180	85030180	85050180	85060180	85090180

COAXIAL CABLES

Do you have questions concerning our products or want to place an order?

We look forward to your call!
+49 511 757086

Do you already know, which products you need?
shop.brauntelecom.com



KLASSE
A
CLASS

Parameter	Frequency [MHz]	HD-063	HD-083	HD-103	HD-113	HD-113-Hydra	HD-163	HD-223
Micro Duct : Diameter (inner/outer) [mm]		-	-	-	-	3,5/5,0	-	-
Structure								
Inner conductor [mm]		0,6 Cu	0,81 Cu	1,02 Cu	1,13 CU	1,13 CU	1,63 Cu	2,2 CU
Isolation [mm]		2,7 FPE	3,6 FPE	4,6 FPE	4,8 FPE	4,8 FPE	7,2 FPE	10,2 FPE
Braid coverage CSnB		65 %	63 %	62 %	60 %	60 %	55 %	60 %
Foil		Trishield	Trishield Foil	Trishield	Trishield Foil	Trishield	Trishield	Trishield
Sheath [mm]		4,3	5,8	6,8	6,8	6,8 x 14	10,0	13,8
Loss at 20°C [dB]								
	5	2,8	2,1	1,5	1,4	1,4	1,2	0,6
	50	7,8	5,7	4,3	4,1	4,1	2,8	2,1
	100	10,9	8,1	5,9	5,7	5,7	4,1	2,9
	230	16,8	11,9	8,5	8,2	8,2	6,1	4,7
	470	24,2	17,7	13,6	12,3	12,3	8,9	7,1
	860	33,2	23,9	18,6	16,9	16,9	12,6	9,8
	1.006	35,9	25,7	20,1	19,2	19,2	13,9	10,9
	1.750	45,8	35,1	27,1	25,7	25,7	18,6	14,9
	2.150	53,9	38,6	30,5	28,9	28,9	20,7	16,8
	2.400	56,9	41,2	33,1	30,6	30,6	22,1	18,2
Return loss [min. dB]								
	5 – 470	> 26	> 26	> 26	> 26	> 26	> 26	> 26
	470 – 862	> 23	> 23	> 23	> 23	> 23	> 23	> 23
	862 – 2.150	> 18	> 18	> 18	> 18	> 18	> 18	> 18
Electrical features								
Impedance [Ω]		75 ± 2	75 ± 2	75 ± 2	75 ± 2	75 ± 2	75 ± 2	75 ± 2
Capacity approx. [pF]		53	53	53	53	53	53	53
Shortening factor		0,82	0,82	0,84	0,84	0,84	0,84	0,83
DC resistance at 20°C								
Inner conductor [Ω/100 m max.]		6,19	3,45	2,21	1,78	1,78	0,85	0,47
Screening Class								
Transfer impedance [mΩ/m]	5 – 30	< 2,5	< 2,5	< 2,5	< 1,5	< 1,5	< 1,5	< 2,5
Screening [dB]	30 – 1.000	> 100	> 110	> 110	> 110	> 110	> 110	> 95
Mechanical features								
Min. setting radius [mm] once		25	30	35	35	50	75	150
Max. tensile strength [N]		30	50	110	110	110	225	400
Weight [approx. kg/km]		25	39	50	50	105	85	155
Standard package [m]		250	100/300/500	100/250/500	100/250/500	500	100/250/500	100/500
Fire behavior PVC		Eca	Eca	Eca	Eca	Eca	Eca	Eca
Fire behavior PE		Fca	Fca	Fca	Fca	Fca	Fca	Fca
Fire behavior LSNH		Fca	Dca, s2, d1, a1	Dca, s2, d1, a1	Dca, s1a, d2, a1	Dca, s2, d1, a1	Dca, s2, d1, a1	Dca, s2, d1, a1
UV-resistant (all sheaths)		Yes	Yes	Yes	Yes	Yes	Yes	Yes
Order No.								
Type 1) PVC sheath		6550630x	6550830x	6551030x	6551130x	a. A.	6551632x	a. A.
Type 2) PE sheath		a. A.	a. A.	a. A.	a. A.	a. A.	6551630x	6552230x
Type 3) LSNH/FRNC white		6550631x	6550831x	6551031x	6551130x	65511321	a. A.	a. A.
Type 4) LSNH/ FRNC black		a. A.	a. A.	a. A.	a. A.	65511320	6551631x	6552231x

Cu = copper; S CU = copper clad steel; FPE = physical foam; PE = polyethylene; PVC = polyvinyl chloride; Cu FB = copper foil and copper braid; Al FF = double aluminum-laminated polyester foil (Al-Duofoil); Al B = aluminum braid with coverage in %; CSnB = tin-plated copper braid with coverage in %

Belden

BELDEN
SENDING ALL THE RIGHT SIGNALS



KLASSE
A
CLASS

Parameter	Frequency [MHz]	H121T00	H126T00	PRG11DB+PVC PRG11DB+LSNH	PRG11DB+PE
Type 1) screening > 95 dB		H121T00	H126T00	PRG11DB+PVC	PRG11DB+PE
Type 2) with FRNC sheath		-	-	PRG11DB+LSNH	-
Structure					
Inner conductor [mm]		0,8 Cu	1,0 Cu	1,55 Cu	1,55 Cu
Isolation [mm]		3,5 FPE	4,57 FPE	7,25 FPE	7,25 FPE
Outer conductor [mm]		4,1 Al PET	5,1 Al PET	8,1 DB II	8,1 DB II
Braid coverage		75 % CSnB	60 % CSnB	70 % CSnB	70 % CSnB
Foil		Trishield Foil	Trishield Foil	DB+	DB+
Cheath [mm]		5,0 PVC	6,9 PVC	10,1 PVC	10,1 PE
Color PVC type/FRNC type		white/white*	white/white*	black/black*	black/-*
Loss at 20°C [dB]	5	2,3	1,8	0,9	0,9
	50	5,9	4,7	2,8	2,8
	100	8,1	6,5	3,9	3,9
	230	12,1	9,8	6,1	6,1
	400	15,9	13,0	8,2	8,2
	860	23,6	19,5	12,5	12,5
	1.000	25,6	21,1	13,6	13,6
	1.750	34,5	28,8	18,7	18,7
	2.150	38,6	32,3	21,1	21,1
Return loss [min. dB]	5 – 470	> 20	> 20	> 23	> 23
	470 – 862	> 18	> 18	> 20	> 20
	862 – 2.150	> 16	> 16	> 18	> 18
Electrical features					
Impedance [Ω]		75 ± 3	75 ± 3	75 ± 3	75 ± 3
Capacity approx. [pF]		53	54	55	55
Shortening factor		0,84	0,82	0,81	0,81
DC resistance at 20°C					
Inner conductor [Ω/100 m max.]		3,5	2,3	1,0	0,87
Screening Class					
Transfer impedance [mΩ/m]	5 – 30	< 2,5	< 2,5	< 1,9	< 1,9
Screening [dB]	30 – 1.000	> 95	> 95	> 105	> 105
Mechanical features					
Min. setting radius [mm] once		25	35	100	100
Max. tensile strength [N]		44	55	132	132
Weight [approx. kg/km]		29	52	98	85
Standard package [m]		100/300/500	100/250/500	250/500/1.000	250/500/1.000
Order No.					
Type 1) screening > 95 dB		65110x00	65170xx0	65191xx1	65191xx0
Type 2) with FRNC sheath		-	-	65191xx3	-

Cu = copper; **S CU** = copper clad steel; **FPE** = physical foam; **PE** = polyethylene; **PVC** = polyvinyl chloride; **Cu FB** = copper foil and copper braid; **Al FF** = double aluminum-laminated polyester foil (Al-Duofoil); **Al B** = aluminum braid with coverage in %; **CSnB** = tin-plated copper braid with coverage in %; **DB II** = double aluminum-laminated polyester foil, bonded on the dielectric; **CG** = Core Guard: protective core under DUOBOND foil made of fireproof gel with moisture protection; **DB+** = Patented DUOBOND PLUS system: Metal to metal plated aluminum foil with insulating layer glued under the outer sheath to achieve a screening of > 100 dB from 10 MHz upwards (the screening for the H 126 DB+ is > 95 dB); **AL PET** = Aluminium film, glued with a PET film (Polyester)

Min. installation temperature: -5°C
Operating & storage temperature: PE/PVC: -40 – +80°C, LSNH: -30 – +70°C

* Further colors are available on request.

Subject to technical changes!

Trunk cables



Parameter	Frequency [MHz]						
Type 1) screening > 100 dB		COAX 4 FFB14	COAX 3 FFB20	IKX	NKX	QKX	SKX
Type 2) with FRNC sheath		COAX 4 FFB14 LSNH	COAX 3 FFB20 LSNH	-	-	-	-
Structure							
Inner conductor [mm]		2,2 Cu	3,4 Cu	1,1 Cu	2,2 Cu	3,3 Cu	4,9 Cu
Isolation [mm]		10,2 FPE	14,9 FPE	7,3	8,8	13,4	19,4
Outer conductor [mm]		11,0 CuFB	15,8 CuFB	7,8	9,3	14,0	20,0
Braid coverage		60 %	55 %				
Sheath [mm]		13,8 PE	19,8 PE	11,0 PE	12,5 PE	17,0 PE	24,5 PE
Color PVC-Type/FRNC-Type		black/grey	black/grey	black/-	black/-	black/-	black/-
Loss at 20°C [dB]	10	0,9	0,6				
	50	1,9	1,3	3,7	2,0	1,3	0,9
	100	2,8	1,8	5,4	2,8	1,9	1,3
	230	4,4	2,9	8,6	4,3	2,9	2,0
	300	5,1	3,3	9,8	5,0	3,3	2,3
	470	6,5	4,2	12,3	6,3	4,2	3,0
	860	9,2	5,9	17,7	8,7	5,9	4,2
	1.000	10,0	6,5	19,2	9,5	6,4	4,5
	2.150	15,7	10,2	-	-	-	-
Return loss [min. dB]	5 – 470	> 26	> 26	-	> 23	> 25	> 25
	470 – 862	> 23	> 23	-	> 21	> 23	> 23
	862 – 2.150	> 18	> 18	-	-	-	-
Electrical features							
Impedance [Ω]		75 ± 3	75 ± 3	75 ± 2	75 ± 1,5	75 ± 1,5	75 ± 1,5
Capacity approx. [pF]		54	54	65	51	51	50
Shortening factor		0,82	0,84	0,68	0,88	0,88	0,89
DC resistance at 20°C							
Inner conductor [Ω/100 m max.]		0,45	0,19	2,2	0,56	0,25	0,10
Screening Class							
Transfer impedance [mΩ/m]	5 – 30	< 1,9	< 1,1	< 0,1	< 0,1	< 0,1	< 0,1
Screening [dB]	30 – 1.000	> 100	> 100	> 110	> 120	> 120	> 120
Mechanical features							
Min. setting radius [mm] once		150	200	160	200	300	400
Max. tensile strength [N]		400	1.200	140	350	550	3.000
Weight [approx. kg/km]		170	400	300	185	350	560
Standard package [m]		500/1.000	700/1.050	1.000	1.000	1.000	1.000
Order No.							
Type 1) screening > 100 dB		65440x00	65480x00	65050000	65060000	65070000	65079000
Type 2) with FRNC sheath		65449x00	65489x00	-	-	-	-

Cu = copper; S CU = copper clad steel; FPE = physical foam; PE = polyethylene; PVC = polyvinyl chloride; Cu FB = copper foil and copper braid; AI FF = double aluminum-laminated polyester foil (Al-Duofoil); AI B = aluminum braid with coverage in %; CSnB = tin-plated copper braid with coverage in %; DB II = double aluminum-laminated polyester foil, bonded on the dielectric

Min. installation temperature: -5°C
 Operating & storage temperature: PE: -40 – +70°C, LSNH: -30 – +70°C

Fireproof cables

KLASSE
A
CLASS

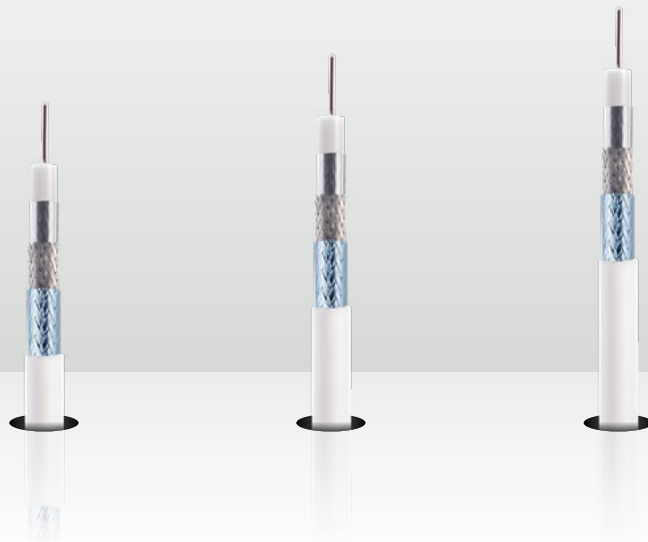

Parameter	Frequency [MHz]	LCD 130A+ 100m	LCD 130A+ 250m	LCD 130A+ 500m
Structure				
Inner conductor [mm]		1,13 Cu	1,13 Cu	1,13 Cu
Isolation [mm]		4,8 PE	4,8 PE	4,8 PE
Outer conductor		2 x Al/pet foil, 1 x CuSn braid	2 x Al/pet foil, 1 x CuSn braid	2 x Al/pet foil, 1 x CuSn braid
Sheath [mm]		6,9 HFFR	6,9 HFFR	6,9 HFFR
Color PVC-Type		white	white	white
Loss at 20°C [dB]				
	5	1	1	1
	50	4,1	4,1	4,1
	100	5,7	5,7	5,7
	450	12	12	12
	860	17,1	17,1	17,1
	1.000	18,5	18,5	18,5
	2.150	28,4	28,4	28,4
	2.400	29,9	29,9	29,9
Return loss [min. dB]				
	5 – 470	26	26	26
	470 – 862	25	25	25
	862 – 1.000	23	23	23
	1.000 – 2.150	20	20	20
Electrical features				
Shortening factor typ.		0,85	0,85	0,85
DC resistance at 20°C				
Inner conductor [$\Omega/100$ m max.]		3	3	3
Screening Class				
Transfer impedance [$m\Omega/m$]	5 – 30	< 0,9	< 0,9	< 0,9
Screening [dB typ.]	30 – 3.000	130	130	130
Mechanical features				
Min. setting radius [mm] once		35	35	35
Max. tensile strength [N]		120	120	120
Ambient temperature range [°C]		-25 – +70	-25 – +70	-25 – +70
Weight [approx. kg/km]		5,1	5,1	5,1
Standard package [m]		100	250	500
Package type				
Fire class acc. BauPVO EN 50575		Non-returnable spool B2ca s1a d0 a1	Roll-off carton packaging B2ca s1a d0 a1	Non-returnable drum B2ca s1a d0 a1
Order No.		82215139	82215142	82215141

Cu = copper; PE = polyethylene; PVC = polyvinyl chloride; Al/pet = metallised PET film, evaporated with aluminium in high vacuum; CuSn = tin-plated copper braid with coverage in %; HFFR = Halogen Free Flame Retardant

CATV AMPLIFIERS

Do you have questions concerning our products or want to place an order?

We look forward to your call!
+49 511 757086

Do you already know, which products you need?
shop.brauntelecom.com

Astro and Axing

86401270
BVS-12-69N



81217352
HVB-31



KLASSE
A
CLASS

Item	Description	Order No.
HVF-V44-G-PG11	Amplifier 40/32 dB, switchable, remote powering, VF-KDG class D4.4	81217405
HVD-44	Amplifier 40/32 dB, switchable, local powering, VF-KDG class D4.4, with equalizer and level control	81217368
HVF-44-G-Ff	Amplifier 40/32 dB, switchable, remote powering, VF-KDG class D4.4, with equalizer and level control	81217415
HVB-21	Amplifier 25 dB, VF-KDG class B2.1, permanently installed adjustable attenuator and equalizer, precorrection of the outgoing cable lines through interstage slope possible	81217351
HVB-22	Amplifier 25 dB, VF-KDG class B2.2, permanently installed adjustable attenuator and equalizer, precorrection of the outgoing cable lines through interstage slope possible	81217369
HVB-31	Amplifier 31 dB, VF-KDG class B3.1, permanently installed adjustable attenuator and equalizer, precorrection of the outgoing cable lines through interstage slope possible	81217352
HVB-32	Amplifier 32 dB, VF-KDG class B3.2, permanently installed adjustable attenuator and equalizer, precorrection of the outgoing cable lines through interstage slope possible	81217353
HVC-32	Amplifier 30 dB, VF-KDG class C3.2, permanently installed adjustable attenuator and equalizer, precorrection of the outgoing cable lines through interstage slope possible	81217354
HVC-42	Amplifier 40 dB, VF-KDG class C4.2, permanently installed adjustable attenuator and equalizer, precorrection of the outgoing cable lines through interstage slope possible	81217355
HVC-43	Amplifier 40 dB, VF-KDG class C4.3, permanently installed adjustable attenuator and equalizer, precorrection of the outgoing cable lines through interstage slope possible	81217356
HV-12-V3	Broadband CATV amplifier 20 dB, VF-KDG class D1.1	81217026
MÜP-1-F	Remotely powered distribution amplifier, VF-KDG class D1.2	81217018
MÜP-1-O	Locally powered distribution amplifier, VF-KDG class D1.2	81217020

KLASSE
A
CLASS



Competence in
Communication
Technologies

Item	Description	Order No.
BVS 12-69N	Amplifier 20 dB, class according to VF-KDG 1TS140 B1.1, B1.2	86401270
BVS 13-69N	Amplifier 30 dB, class according to VF-KDG 1TS140 B3.2	86401370
BVS 15-68	Amplifier 38 dB, class according to VF-KDG 1TS140 C4.2	86401568
BVS-20-69N	Amplifier 38 dB, class according to VF-KDG 1TS140 D4.3	86402070
BVS-14-69N	Amplifier 40 dB, class according to VF-KDG 1TS140 D4.4	86401472

Subject to technical changes!

Delta Electronics, Kathrein and Teleste

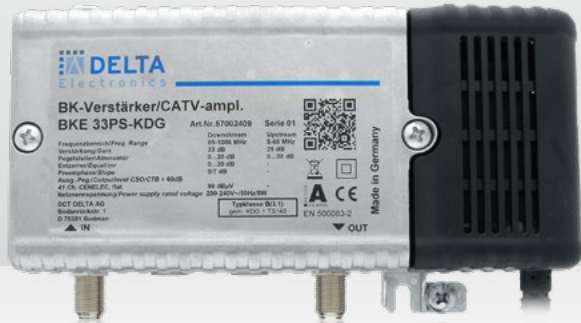

11572409
BKE 33 PS-KDG



82209504
VOS 138/RA 2.0

KLASSE
A
CLASS



Item	Description	Order No.
BKD 40 SF	House amplifier 41 dB, VF-KDG class B4.3; C4.3 KDG 1TS140, incl. return path amplifier RV65-32F	11572327
BKE 22 PS-KDG	House amplifier 20 dB, VF-KDG class B1.1, B1.2, KDG 1TS140, equipped with equalizer and level control	11572408
BKE 33 PS-KDG	House amplifier 33 dB, VF-KDG class B3.1 KDG 1TS140, equipped with equalizer and level control	11572409
BKE 36 PS-KDG	House amplifier 35 dB, VF-KDG class C3.2 & B3.2 KDG 1TS140, equipped with equalizer and level control	11572410
BKE 36 BPS-KDG	House amplifier 35 dB, VF-KDG class B3.2 KDG 1TS140, equipped with equalizer and level control	11574307
BKE 39 PS-KDG	House amplifier 39 dB, VF-KDG class C4.2 KDG 1TS140, equipped with equalizer and level control	11572411
BKD 40 PS	House amplifier 40 dB, VF-KDG class C4.3 KDG 1TS140, equipped with equalizer and level control, flexible return path amplifier, with Ingress Detection Switch, compatible with FROSTA-F	11574318
LHE-1040-P	House amplifier 40 dB, VF-KDG class D4.4 KDG 1TS140, input equalization as well as input and output attenuation adjustable with PADs 0 dB ... 20 dB, local powering, connections 3.5/12 adapters (further adapters on request)	11573569
LHE-1040-RP-65	House amplifier 40 dB, VF-KDG class D4.4 KDG 1TS140, input equalization as well as input and output attenuation adjustable with PADs 0 dB ... 20 dB, remote powering, connections 3.5/12 adapters (further adapters on request)	11573912

KLASSE
A
CLASS



Item	Description	Order No.
VOS 137/RA 2.0	Amplifier 40/34/30 dB local powering, class according to VF-KDG 1TS140 D4.4, variable interstage gain using bridging plugs 40/34/30 dB (delivery status: 34 dB), housing with F-connections	82209503
VOS 138/RA 2.0	Amplifier 40/34/30 dB remote powering RF, class according to VF-KDG 1TS140 D4.4, variable interstage gain using bridging plugs 40/34/30 dB (delivery status: 34 dB), housing with F-connections	82209504
VOS 139/RA 2.0	Amplifier 40/34/30 dB remote powering, class according to VF-KDG 1TS140 D4.4, variable interstage gain using bridging plugs 40/34/30 dB (delivery status: 34 dB), housing with PG 11 connections, the cable fittings are not included	82209129
VOS 43/RA	Amplifier 34/40 dB, local powering, class according to VF-KDG 1TS140 C4.3, variable interstage gain using bridging plugs 34/40 dB, housing with F-connections	82209130
VOS 20/RA-1G	Amplifier 20 dB local powering, class according to VF-KDG 1TS140 B1.1, housing with F-connections	82209131
VOS 29/RA-1G 2.0	Amplifier 30 dB local powering, class according to VF-KDG 1TS140 B3.1, housing with F-connections	82209506
VOS 32/RA-1G	Amplifier 26/32 dB, local powering, class according to VF-KDG 1TS140 C3.2, variable interstage gain using bridging plugs 26/32 dB, housing with F-connections	82209133
VGO 939-1G	Amplifier, class according to VF-KDG 1TS140 D4.4 (local powering)	82244165

KLASSE
A
CLASS



Item	Description	Order No.
DH-5669	Amplifier 31 dB, local powering, class according to VF-KDG 1TS140 B3.1, 0 ... 18 dB variable attenuator	86380000
DH-1660	Amplifier 31 dB, local powering, class according to VF-KDG 1TS140 B3.2	86380005
DH-6768-VA	Amplifier 36 dB, local powering, class according to VF-KDG 1TS140 C3.2, 0 ... 18 dB variable attenuator	86380010
DH-6868-VA	Amplifier 39 dB, local powering, class according to VF-KDG 1TS140 C4.2, 0 ... 18 dB variable attenuator	86380015
DH-6908-VA	Amplifier 41 dB, local powering, class according to VF-KDG 1TS140 C4.3, configuration with gain control	86380020
DH-4030-R065	Amplifier 40 dB, local powering, class according to VF-KDG 1TS140 D4.4	86380030
DH-4030-R065-AC	Amplifier 40 dB, remote powering, class according to VF-KDG 1TS140 D4.4	86380032

Triax and fixed-value attenuator pads



81323266
GHV 140 CD



10320600
Amini 6



Item	Description	Order No.
GHV 120 B	Amplifier 20 dB, class according to VF-KDG 1TS140 B1.1	81323252
GHV 130 B	Amplifier 30 dB, class according to VF-KDG 1TS140 B3.2	81323259
GHV 135 C	Amplifier 35 dB, class according to VF-KDG 1TS140 C3.2	81323262
GHV 138 C	Amplifier 38 dB, class according to VF-KDG 1TS140 C4.2	81323263
GHV 140 CD	Amplifier 40 dB, class according to VF-KDG 1TS140 D4.3	81323266
GPV 150 D	Amplifier 41 dB, class according to VF-KDG 1TS140 D4.4	81323270
GPV 150 DL	Amplifier 41 dB, class according to VF-KDG 1TS140 D4.4, remote powering	81323274



1.218 MHz fixed value attenuator pads ("Aminis")

Highest quality fixed-value attenuator pads with gold-plated pins for adjustment of attenuation, equalization and cable simulation

Item	Value as attenuator	Value as equalizer	Order No.
Amini 0	0 dB	0 dB	10320000
Amini 1	1,0 dB	1,0 dB	10320100
Amini 2	2,0 dB	2,0 dB	10320200
Amini 3	3,0 dB	3,0 dB	10320300
Amini 4	4,0 dB	4,0 dB	10320400
Amini 5	5,0 dB	5,0 dB	10320500
Amini 6	6,0 dB	6,0 dB	10320600
Amini 7	7,0 dB	7,0 dB	10320700
Amini 8	8,0 dB	8,0 dB	10320800
Amini 9	9,0 dB	9,0 dB	10320900
Amini 10	10,0 dB	10,0 dB	10321000
Amini 11	11,0 dB	11,0 dB	10321100
Amini 12	12,0 dB	12,0 dB	10321200
Amini 13	13,0 dB	13,0 dB	10321300
Amini 14	14,0 dB	14,0 dB	10321400
Amini 15	15,0 dB	15,0 dB	10321500
Amini 16	16,0 dB	16,0 dB	10321600
Amini 17	17,0 dB	17,0 dB	10321700
Amini 18	18,0 dB	18,0 dB	10321800
Amini 19	19,0 dB	19,0 dB	10321900
Amini 20	20,0 dB	20,0 dB	10322000



Amini Set in a practical case in 1 dB steps

Small	10 pcs of each 1 – 10 dB	Order No. 10322300
Large	10 pcs of each 1 – 20 dB	Order No. 10322301

Do you have questions concerning our products or want to place an order?

We look forward to your call!
+49 511 757086

Do you already know, which products you need?
shop.brauntelecom.com



